

Electropneumatic Positioner Type 3730-2



Fig. 1 · Type 3730-2

Mounting and Operating Instructions

EB 8384-2 EN

Firmware version 1.3x
Edition April 2005



Contents	Page
1	Design and principle of operation 8
1.1	Additional equipment 9
1.2	Technical data 10
2	Attachment to the control valve – Mounting parts and accessories . . . 13
2.1	Direct attachment 16
2.1.1	Type 3277-5 Actuator 16
2.1.2	Type 3277 Actuator 18
2.2	Attachment according to IEC 60534-6 20
2.3	Attachment to Type 3510 Micro-flow Valve. 22
2.4	Attachment to rotary actuators 24
2.5	Reversing amplifier for double-acting actuators 26
2.6	Attaching an external position sensor 28
2.6.1	Mounting the position sensor with direct attachment. 28
2.6.2	Mounting the position sensor with attachment according to IEC 60534-6 30
2.6.3	Mounting the position sensor to Type 3510 Micro-flow Valve 31
2.6.4	Mounting the position sensor to rotary actuators 32
3	Connections 34
3.1	Pneumatic connections 34
3.1.1	Signal pressure gauges 34
3.1.2	Supply pressure 34
3.2	Electrical connections 35
3.2.1	Switching amplifiers 37
4	Operation 38
4.1	Operator controls and display 38
4.2	Enabling and selecting parameters 40
4.3	Operating modes 41
4.3.1	Automatic and manual operating modes 41
4.3.2	SAFE – Fail-safe position 42
5	Start-up and settings 42
5.1	Determining the fail-safe position 42
5.2	Setting the volume restriction Q 43
5.3	Limiting the signal pressure 43
5.4	Checking the operating range of the positioner 43
5.5	Initialization 45
5.5.1	Initialization modes 46
5.6	Fault/failure 53
5.7	Zero calibration 54

5.8	Reset to default values	54
5.9	Start-up via local interface (SSP)	55
6	Status and diagnostic alarms	55
6.1	Standard EXPERT diagnostics	55
6.2	Extended EXPERT+ diagnostics	56
6.3	Classification of the status alarms and condensed status.	56
7	Adjusting the limit switch	59
8	Quick start-up guide	61
8.1	Mounting	61
8.2	Start-up.	62
8.3	Initialization	63
8.3.1	Simplest method (<i>MAX</i>)	63
8.3.2	Precise method (<i>NOM</i>)	63
8.3.3	Manual method (<i>MAN</i>)	63
9	Retrofitting an inductive limit switch	64
10	Maintenance	65
11	Servicing explosion-protected devices	65
12	Code list	66
13	Setting with TROVIS-VIEW software – Parameter list	80
13.1	General	80
13.2	Starting TROVIS-VIEW and performing basic settings	80
13.3	Setting the parameters.	84
13.4	Parameter list	85
14	Dimensions in mm	103
	Test certificates	104

General safety instructions



- ▶ *The positioner may only be assembled, started up or operated by trained and experienced personnel familiar with the product. According to these mounting and operating instructions, trained personnel is referred to as individuals who are able to judge the work they are assigned to and recognize possible dangers due to their specialized training, their knowledge and experience as well as their knowledge of the relevant standards.*
 - ▶ *Explosion-protected versions of this positioner may only be operated by personnel who have undergone special training or instructions or who are authorized to work on explosion-protected devices in hazardous areas. Refer to section 11 on Servicing explosion-protected versions.*
 - ▶ *Any hazards that could be caused by the process medium, the operating pressure, the signal pressure or by moving parts of the control valve are to be prevented by means of the appropriate measures.*
 - ▶ *If inadmissible motions or forces are produced in the actuator as a result of the supply pressure level, it must be restricted by means of a suitable supply pressure reducing station.*
 - ▶ *Proper shipping and appropriate storage are assumed.*

 - ▶ **Note!** *The device with a CE marking fulfils the requirements of the Directives 94/9/EC (ATEX) and 89/336/EEC (EMC). The declaration of conformity can be viewed and downloaded on the Internet at <http://www.samson.de>.*
-

Article code		Type 3730-2															
		X	X	X	X	X	0	0	X	0	X	0	0	X	X	X	
Explosion protection																	
Without		0															
⊕ II 2 G EEx ia IIC T6/II 2 D IP 65 T 80 °C acc. to ATEX		1															
CSA/FM intrinsically safe/non incendive		3															
⊕ II 3 G EEx na II T6 acc. to ATEX		8															
Additional equipment																	
Inductive limit switch	Without	0															
	With Type SJ 2-SN	1				0											
Sol. valve SIL 4	Without			0													
	24 V DC			4													
Analog position transmitter	Without					0											
	With					1											
External Position sensor	Without							0									
	With					0		1									
Diagnostics	Expert									1							
	Expert + (extended)									2							
Housing material	Aluminum											0					
	Stainless steel 1.4581							0				1					
Positioner for special applications	Without														0		
	Free of substances that impair painted surfaces														1		
	Exhaust air with pneum. connection ¼ NPT														2		
Special versions	Without														0	0	0
	IECEX							1							0	1	2

Modifications of positioner firmware in comparison to previous versions	
Previous	New
1.01	1.10
	Via the serial interface and the serial interface adapter, the positioner can be configured and operated using TROVIS-VIEW software.
	The following additional status indications were implemented: Code 76 - No emergency mode Code 77 - Program loading error Displays number of zero calibrations performed since the last initialization.
	For initialization of "AIR TO CLOSE" actuators, the direction of action (Code 7) is automatically set to increasing/decreasing.
	Code 3 , the activation period of the enabled configuration function was extended to 120 s.
1.10	1.20
	Electronics changed, no new functions added.
1.20	1.30
	New EXPERT+ diagnostics functions (Code 48) added Positioner in EXPERT+ version with extended diagnostics features.
	A running initialization can be canceled by pressing the pushbutton.

1 Design and principle of operation

The electropneumatic positioner is mounted to pneumatic control valves and is used to assign the valve position (controlled variable x) to the control signal (reference variable w). The DC control signal received from a control unit is compared to the travel or rotational angle of the control valve and issues a signal pressure (output variable y).

The positioner is designed depending on the corresponding accessories for direct attachment to Type 3277 Actuators or for attachment to actuators according to IEC 60534-6 (NAMUR).

Additionally, a coupling wheel included in the accessories is required to transfer the rotary motion for rotary actuators according to VDI/VDE 3845.

Springless rotary actuators require an accessory reversing amplifier to permit the powered operation in either direction.

The positioner basically consists of a travel sensor system that functions proportional to the resistance, an analog i/p module with downstream booster as well as the electronic unit with a microcontroller.

The positioner is fitted with three binary contacts as standard: A fault alarm output is used to indicate a fault to the control station and two configurable software limit switches to indicate the valve's end positions.

The position of the valve is transmitted as linear travel motion or angle of rotation via pick-up lever and travel sensor (2) to an analog PD controller (3). Simultaneously, an A/D converter (4) transmits the position of the valve to the microcontroller (5). The PD

controller compares this actual position to the 4 to 20 mA DC control signal (reference variable) after it has been converted by the A/D converter (4).

In case of a system deviation, the operation of the i/p converter (6) is changed so that the actuator (1) is filled or vented via the downstream air capacity booster (7). This causes the closure member of the control valve to move to the position determined by the reference variable.

The pneumatic air capacity booster (7) and the pressure regulator (8) are provided with supply air. An intermediate flow regulator (9) with fixed settings is used to purge the positioner and also guarantees trouble-free operation of the pneumatic booster. The output signal pressure supplied by the booster can be limited over the software.

The volume restriction Q (10) is used to optimize the positioner by adapting it to the actuator size.

Serial interface

The positioner is equipped with an interface to allow the SAMSON TROVIS-VIEW Configuration and Operator Interface software to transmit data and parameters over an adapter cable from the RS-232 interface of a computer to the positioner. Refer to section 13.

To detect any valve faults at an early stage, the positioner can optionally be equipped with EXPERT+ valve diagnostics. You can access the functions provided by EXPERT+ valve diagnostics over TROVIS-VIEW software and over the DTM file of the device. Refer to Data Sheet T 8388 EN for more details on EXPERT+ valve diagnostics. Instructions on how to operate the software can be

found in the Operating Instructions EB 8388 EN.

1.1 Additional equipment

As an option, the device can be additionally equipped with a solenoid valve for forced venting, an analog position transmitter, an inductive limit switch or an external position sensor.

Version with solenoid valve

If the operating voltage for the solenoid valve (12) fails, the supply pressure for the i/p module is vented to the atmosphere. The positioner can no longer operate and the

control valve moves to the fail-safe position determined by the actuator, independent of the reference variable.

Positioner with position transmitter

The position transmitter (13) is a two-wire transmitter and issues the travel sensor signal as a 4 to 20 mA signal processed by the microcontroller.

Since this signal is issued independent of the positioner's input signal (min. current 3.8 mA), the actual travel/angle of rotation is controlled in real-time. Additionally, the position transmitter provides the possibility of signaling a positioner fault over a signal current of <2.4 mA or >21.6 mA.

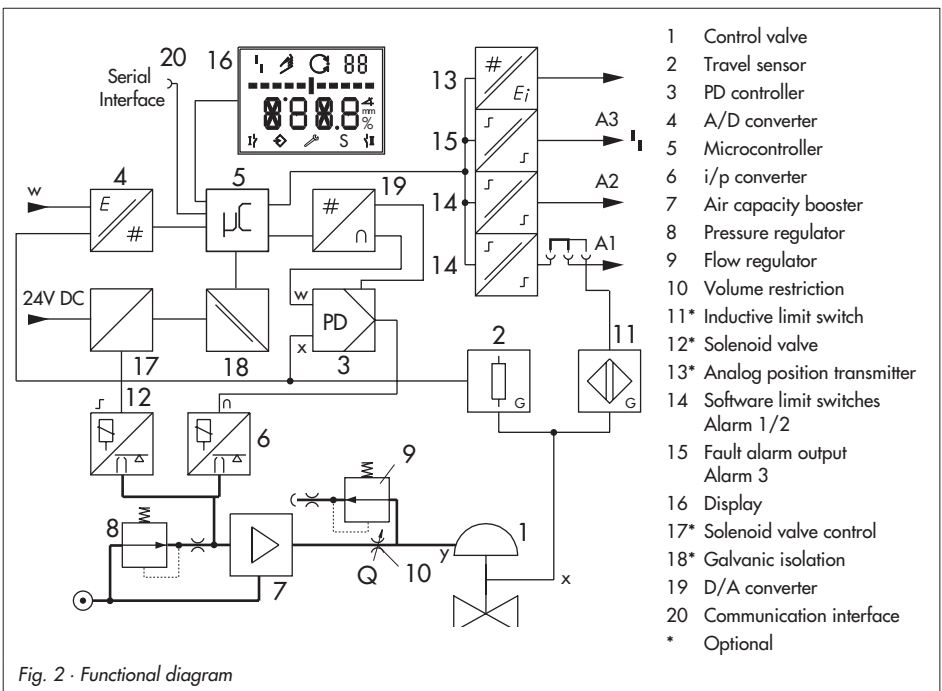

Fig. 2 · Functional diagram

Version with inductive limit switch

The rotary shaft of the positioner carries an adjustable tag which actuates the installed proximity switch.

The optional inductive limit switch (11) leads to A1 and the software limit switch, which remains in operation, leads to A2.

Version with external position sensor

In this version, only the sensor is mounted to the control valve. The positioner is located separately from the valve.

The connection of x and y signals to the valve is established via cable and air hosing (only for non-hazardous areas and without inductive limit switch).

1.2 Technical data

Positioner	
Nominal travel, adjustable	Direct attachment to Type 3277: 3.6 to 30 mm, attachment acc. to IEC 60534-6: 3.6 to 200 mm or 24° to 100° opening angle for rotary actuators
Travel range	Adjustable within the nominal travel/nominal angle, max. ratio 1 : 5
Reference variable w	Signal range 4 to 20 mA, 2-wire unit, reverse polarity protection, min. span 4 mA, static destruction limit 100 mA
Minimum current	3.6 mA for display, 3.8 mA for operation
Load impedance	Version without explosion protection: ≤ 6 V (corresponding to 300 Ω at 20 mA), Explosion-protected version: ≤ 7 V (corresponding to 350 Ω at 20 mA)
Supply air	Supply pressure from 1.4 to 6 bar (20 to 90 psi), Air quality acc. to ISO 8573-1 Edition 2001: Max. particle size and density: Class 4 Oil content: Class 3, pressure dew point: Class 3 or at least 10 K beneath the lowest ambient temperature to be expected
Signal pressure (output)	0 bar up to supply pressure, limitable to 1.4/2.4/3.7 ±0.2 bar via software
Characteristic, user-defined adjustable over operating software	Linear/equal percentage/reverse equal percentage/butterfly valve linear/ butterfly valve eq. percentage/rotary plug valve linear/rotary plug valve eq. percentage/segmented ball valve linear/segmented ball valve eq. percentage Deviation from terminal-based conformity ≤ 1 %
Hysteresis	≤ 0.3 %
Sensitivity	≤ 0.1 %

Transit time	Separately adjustable up to 240 seconds for supply air and exhaust air
Direction of action	Reversible
Air consumption, steady state	Independent from supply pressure approx. 110 l _n /h
Air delivery Actuator pressurized Actuator vented	At Δp = 6 bar: ≥ 8.5 m _n ³ /h, at Δp = 1.4 bar: 3.0 m _n ³ /h K _{Vmax} (20 °C) = 0.09 at Δp = 6 bar: ≤ 14.0 m _n ³ /h, at Δp = 1.4 bar: 4.5 m _n ³ /h K _{Vmax} (20 °C) = 0.15
Permissible ambient temperature	-20 to +80 °C, with metal cable gland -40 to +80 °C The limits specified in the EC Type Examination Certificate additionally apply for explosion-protected devices.
Influences	Temperature: ≤ 0.15 %/10 K Supply air: None Vibration: ≤ 0.25 % up to 2000 Hz and 4 g acc. to IEC 770
Electromagnetic compatibility	Complying with EN 61000-6-2, EN 61000-6-3 and NAMUR Recommendation NE 21
Explosion protection	⊕ II 2 G EEx ia IIC T6 / II 2 D IP 65 T 80 °C or ⊕ II 3 G EEx nA II T6 / II 3 D IP 65 T 80 °C IECEx ia IIC T6 / IP 54 and IP 65 T 80 °C FM/CSA intrinsically safe Class I, II, III, Division 1, Group A, B, C, D, E, F, G, T6 FM/CSA non incandive Class I, Division 2, Group A, B, C, D, T6
Degree of protection	IP 65
Communication (local)	SAMSON SSP interface and serial interface adapter
Software requirements	TROVIS-VIEW with database module 3730-2

Binary contacts	1 fault alarm contact, 2 software limit switches with configurable limit values, reverse polarity protection	
Signal status No response: Response:	Without explosion protection Conductive (R = 348 Ω) Non-conducting	Ex.-protected version: ≥ 2.1 mA ≤ 1.2 mA
Operating voltage	Positioners with model no. .../9000 only for connection to signal converter acc. to EN 60947-5-6. All other versions also for connection to binary input of the PLC acc. to EN 61131, P _{max} = 400 mW	Only for connection to signal converter acc. to EN 60 957-5-6

Design and principle of operation

Solenoid valve	SIL 4 approval acc. to IEC 61508
Input	24 V DC reverse polarity protection, static destruction limit 40 V; Current consumption $I = \frac{U - 5.6 \text{ V}}{4020 \Omega}$ (corresponding to 4.5 mA at 24 V)
Signal	Signal "0" no pick-up $\leq 15 \text{ V}$ Signal "1" safe pick-up $>19 \text{ V}$
Service life	$>2 \times 10^5$ switching cycles
Implementation in safety-relevant systems in compliance with IEC 61508	Probability of failure on demand of safety functions PFD $< 2.8 \times 10^{-7}$ for a confidence level of 95 %. The safe failure fraction (SFF) according to Table A1 in IEC 61508-2 is greater or equal to 0.99. The valves are therefore suitable for implementation in safety-related systems with a hardware fault tolerance of 1 or 2 up to and including SIL 4.
Analog position transmitter	Two-wire transmitter
Supply voltage	12 to 30 V DC, reverse polarity protection, static destruction limit 40 V
Output signal	4 to 20 mA
Direction of action	Reversible
Operating range	0 to 100 % of the travel range, optional also for fault indication over 2.4 or 21.6 mA
Characteristic	Linear
Hysteresis and HF influence	Same as positioner
Ripple content of output signal	0.6 % at 28 Hz acc. to IEC 381 T1
Other influences	Same as positioner
Fault indication	Can be issued with current signal $< 2.4 \text{ mA}$ or $> 21.6 \text{ mA}$
Inductive limit switch	Type SJ 2SN Proximity Switch
For connection to switching amplifier acc. to EN 60947-5-6. Can be used in combination with a software limit switch.	
External position sensor	
Nominal travel	Adjustable same as positioner
Cable	Max. 10 m with M12x1 connector, designed for continuous flexing, flame retardant acc. to VDE 0472, resistant to oils, lubricants as well as other corrosive media
Ambient conditions	Perm. temperature: -40 to $+105 \text{ }^\circ\text{C}$, the limits specified in the EC Type Examination Certificate additionally apply for explosion-protected devices. Vibration immunity: up to 10 g in the range between 10 and 2000 Hz
Degree of protection	IP 67
Materials	Housing: Die-cast aluminum GD AlSi12 acc. to DIN 1725 (3.2582), chromated and plastic coated, special version. CrNiMo (1.4581); External parts: Stainless steel 1.4571 and 1.4301. Cable gland M20x1.5, black polyamide
Weight	Approx. 1.0 kg

2 Attachment to the control valve – Mounting parts and accessories

The positioner can be attached either directly to a SAMSON Type 3277 Actuator or according to IEC 60534-6 (NAMUR) to control valves with cast yokes or rod-type yokes as well as to rotary actuators according to VDI/VDE 3845.

For attachment to the various actuators, corresponding mounting parts and accessories are required. These are listed with their order numbers in Tables 1 to 5.

On attaching the positioner, it is important to observe the assignment between lever and pin position according to the travels listed in the travel tables.

The tables show the maximum adjustment range at the positioner. The travel that can be implemented at the valve is restricted by the pin position used and additionally by the actuator spring compression required. The positioner is standard equipped with the lever **M** (pin position **35**).

Note!

If the standard mounted lever M (pin position 35) is replaced, the newly mounted lever must be moved once all the way as far as it will go in both directions to adapt it to the internal measuring lever.

Travel table for direct attachment to Type 3277 Actuator							
Type 3277-5 and 3277 Actuators	Actuator size	Rated travel	Adjustment range at positioner		Required lever	Assigned pin position	
	cm ²	mm	Min.	Travel Max.			
		120	7.5	5	17.6	M	25
		120/240/350	15	7.5	35.4	M	35
	700	30	10	50	M	50	
Travel table for attachment according to IEC 60534-6 (NAMUR)							
Type 3271 Actuator	SAMSON valves		Other valves/actuators			Required lever	Assigned pin position
	cm ²	Rated travel mm	Min.	Travel	Max.		
	60 and 120 with Type 3510 Valve	7.5	3.6		17.6	S	17
	120	7.5	5.0		17.6	M	25
	120/240/350	15	7.5		35.4	M	35
	700/1400/2800	15 and 30/30	10		50	M	50
	1400/2800	60	14.0		70.8	L	70
	1400/2800	60	20.0		100	L	100
	2800	120	40.0		200	XL	200
Rotary actuators		Opening angle 24° to 100°				M	90°

Attachment to the control valve – Mounting parts and accessories

Table 1		Direct attachment to Type 3277-5 Actuator, see Fig. 3		Order no.	
Mounting parts	For actuators with 120 cm ² effective diaphragm area			1400-7452	
Accessories for the actuator	Switchover plate (old) for Actuator Type 3277-5xxxxx. 00 (old)			1400-6819	
	Switchover plate new for Actuator Type 3277-5xxxxx. 01 (new)			1400-6822	
	Connecting plate for additional attachment of a solenoid valve G 1/8			1400-6820	
	Connecting plate (old) for Actuator Type 3277-5xxxxx. 00 (old) 1/8 NPT			1400-6821	
	Connecting plate new for Actuator Type 3277-5xxxxx. 01 (new)			1400-6823	
<i>Note: Only new switchover and connecting plates can be used with new actuators (Index 01). Old and new plates are not interchangeable.</i>					
Accessories for the positioner	Connecting plate (6)	G ¼: 1400-7461	¼ NPT: 1400-7462		
	or pressure gauge bracket (7)	G ¼: 1400-7458	¼ NPT: 1400-7459		
	Pressure gauge mounting kit (8) (output/supply)	St. st./Bs: 1400-6950	St. st./St. st.: 1400-6951		
Table 2		Direct attachment to Type 3277 Actuator, see Fig. 4			
Accessories	Mounting parts for actuators with 240, 350 and 700 cm ² , see Fig. 4		1400-7453		
	Required piping with screw fittings for "Actuator stem retracts" or when the top diaphragm chamber is filled with air	cm ²	Steel	St. steel	
		240	1400-6444	1400-6445	
		350	1400-6446	1400-6447	
	700	1400-6448	1400-6449		
Connection block with seals and screw		G ¼: 1400-8811	¼ NPT: 1400-8812		
Pressure gauge mounting kit (output and supply)		St.st./Bs: 1400-6950	St.st./St.st.: 1400-6951		

Table 3 Attachment to NAMUR ribs or control valves with rod-type yokes (rod diameter Ø 35 mm or smaller) according to IEC 60534-6, see Fig. 5			
Travel in mm	Lever	For actuators	Order no.
7.5	S	Type 3271-5 Actuator with 60/120 cm ² on Type 3510 Valve, see Fig. 6	1400-7457
5 to 50	Without (lever M on basic model)	Actuators from other manufacturers and Type 3271 with 120 to 700 cm ²	1400-7454
14 to 100	L	Actuators f. other manufacturers and Type 3271 w. 1400 cm ²	1400-7455
40 to 200	XL	Actuators from other manufacturers and Type 3271 with 2800 cm ² , 120 mm travel	1400-7456
30 or 60	L	Type 3271 Actuator with 2800 cm ² and 30 or 60 mm travel	1400-7466
Mounting brackets for Emerson and Masoneilan linear actuators In addition, a mounting kit acc. to IEC 60534-6 is required depending on the travel. See row above.			1400-6771
Accessories	Connecting plate	G ¼: 1400-7461 ¼ NPT: 1400-7462	
	or pressure gauge bracket (7)	G ¼: 1400-7458 ¼ NPT: 1400-7459	
	Pressure gauge mounting kit (output/supply)	St.st./Bs: 1400-6950 St.st./St.st.: 1400-6951	

Table 4 Attachment to rotary actuators (VDI/VDE 3845 for all sizes of fixing level 2) see Figs. 7 and 8			
Mounting parts	With follower clamp and coupling wheel	VDI/VDE 3845 for all sizes of fixing level 2 for Type 3278 Actuator with 160/320 cm ² for Camflex II	1400-7448 1400-7614 1400-9120
Accessories	Connecting plate	G ¼: 1400-7461 ¼ NPT: 1400-7462	
	or pressure gauge bracket (7)	G ¼: 1400-7458 ¼ NPT: 1400-7459	
	Pressure gauge mounting kit (output/supply)	St.st./Bs: 1400-6950 St.st./St.st.: 1400-6951	

Table 5 General accessories			
Accessories	Pneumatic reversing amplifier for double-acting actuators	G ¼ ¼ NPT	1079-1118 1079-1119
	Cable gland M20 x 1.5 Nickel-plated brass		1890-4875
	Adapter M 20 x 1.5 to ½ NPT, aluminum		0310-2149
	Retrofit kit for inductive limit switch 1x SJ 2-SN		1400-7460
	Cover plate with list of parameters and operating instructions	German/English (standard) English/Spanish English/French	1190-0761 1190-3100 1190-3142

2.1 Direct attachment

2.1.1 Type 3277-5 Actuator

Refer to Table 1 on page 14 for the required mounting parts as well as the accessories with their order numbers.

Note the travel table on page 13!

Actuator with 120 cm²

Depending on the type of positioner attachment, the signal pressure is routed either left or right of the yoke through a bore to the actuator diaphragm. Depending on the fail-safe action of the actuator "Actuator stem extends" or "Actuator stem retracts" (valve closes or opens if the supply air fails), the switchover plate (9) must first be attached to the actuator yoke. Align the switchover plate with the corresponding symbol for left or right attachment according to the marking (view looking onto the switchover plate).

1. Mount connecting plate (6) or pressure gauge bracket (7) with pressure gauges onto the positioner, making sure both seal rings (6.1) are seated properly.
2. Remove vent plug (4) on the back of the positioner and close the signal pressure output "Output 38" on the connecting plate (6) or on the pressure gauge bracket (7) with the stopper (5) included in the accessories.
3. Place follower clamp (3) on the actuator stem, align and screw tight so that the mounting screw is located in the groove of the actuator stem.
4. Mount cover plate (10) with narrow side of the cut-out opening (Fig. 3, on the

left) pointing towards the signal pressure connection. Make sure that the bonded gasket (14) points towards the actuator yoke.

5. **15 mm travel:** Keep the follower pin (2) at lever **M** (1) on the back of the positioner in the pin position **35** (delivered state).

7.5 mm travel: Remove the follower pin (2) from the pin position **35**, reposition it in the bore for pin position **25** and screw tight.

6. Insert formed seal (15) in the groove of the positioner casing.
7. Place positioner on the cover plate (10) in such a manner that the follower pin (2) rests on the top of the follower clamp (3). Adjust the lever (1) correspondingly and open the positioner cover to hold the positioner shaft in position at the cap or the switch (Fig. 16).

The lever (1) must rest on the follower clamp with spring force.

Mount the positioner on the cover plate (10) using the two fixing screws. During the installation make sure that the seal ring (10.1) is inserted in the bore of the intermediate plate.

8. Mount cover (11) on the other side. Make sure that the vent plug points downwards when the control valve is installed to allow any condensed water that collects to drain off.

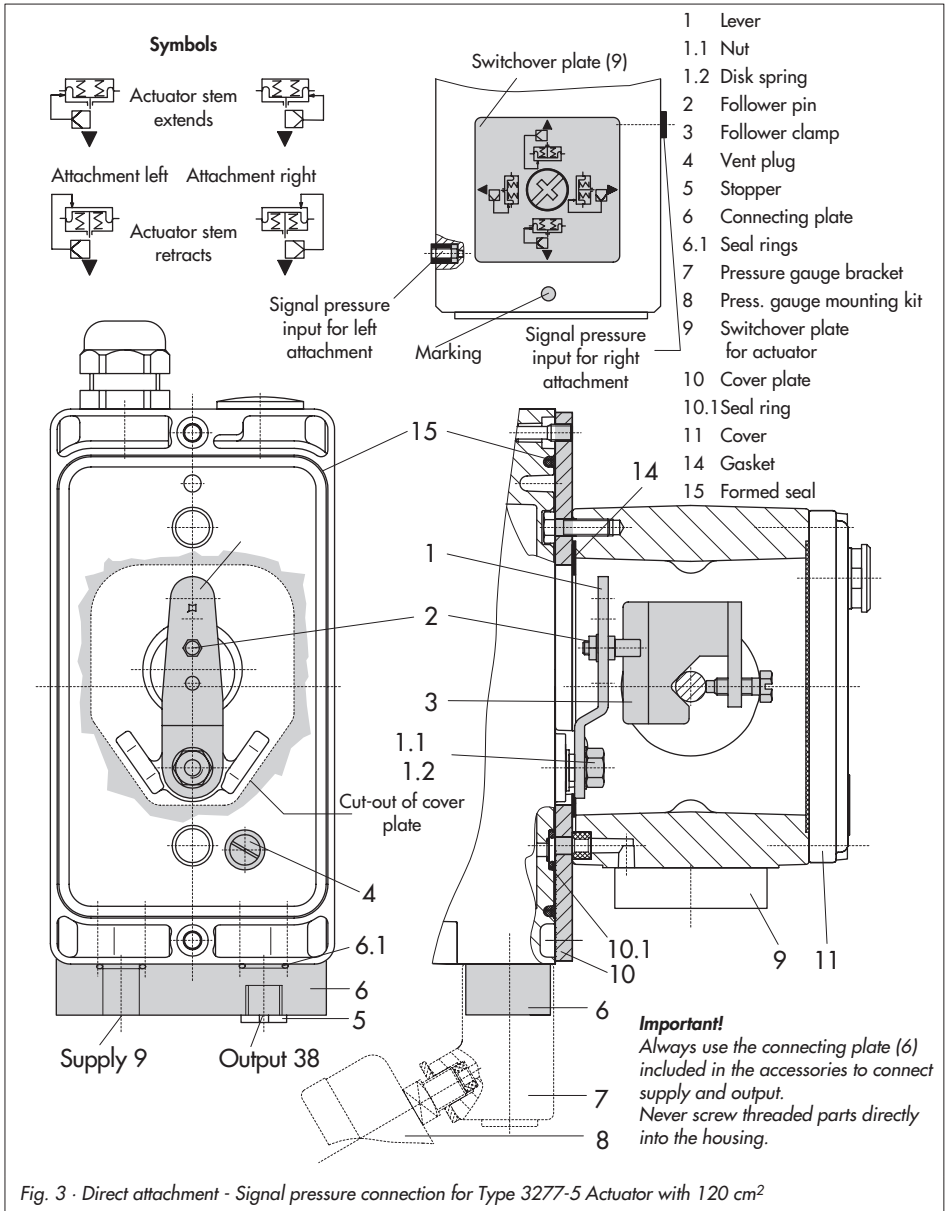

Fig. 3 · Direct attachment - Signal pressure connection for Type 3277-5 Actuator with 120 cm²

2.1.2 Type 3277 Actuator

Refer to Table 2 on page 14 or the required mounting parts as well as the accessories with their order numbers.

Note the travel table on page 13!

Actuators with 240 to 700 cm²

The positioner can be mounted either on the left or on the right side of the yoke. The signal pressure is routed to the actuator over the connection block (12), for actuators with fail-safe action "Actuator stem extends" internally through a bore in the valve yoke and for "Actuator stem retracts" through external piping.

- Place follower clamp (3) on the actuator stem, align and screw tight so that the mounting screw is located in the groove of the actuator stem.
- Mount cover plate (10) with narrow side of the cut-out opening (Fig. 4, on the left) pointing towards the signal pressure connection. Make sure that the bonded gasket (14) points towards the actuator yoke.
- For actuators with 700 cm², remove the follower pin (2) at lever **M** (1) on the back of the positioner from pin position **35**, reposition it in the bore for pin position **50** and screw tight.
For actuators 240 and 350 cm² with 15 mm travel, the follower pin (2) remains in pin position **35**.
- Insert formed seal (15) in the groove of the positioner casing.
- Place positioner on the cover plate in such a manner that the follower pin (2) rests on the top of the follower clamp (3). Adjust the lever (1) correspondingly and open the positioner cover to hold the positioner shaft in position at the cap or the switch (Fig. 16). The lever (1) must rest on the follower clamp with spring force. Mount the positioner on the cover plate (10) using the two fixing screws.
- Make sure that the tip of the gasket (16) projecting from the side of the connection block (12) is positioned above the actuator symbol that corresponds with the actuator with fail-safe action "Actuator stem extends" or "Actuator stem retracts." If necessary, remove the three fixing screws and the cover. Then reposition the gasket (16) turned by 180°. The previous version of the connection block (Fig. 4, bottom) requires the switch plate (13) to be turned such that the corresponding actuator symbol points to the marking.
- Place the connection block (12) with the associated seal rings against the positioner and the actuator yoke. Screw it tight using the fixing screw (12.1). For actuators with fail-safe action "Actuator stem retracts", additionally remove the stopper (12.2) and fit on the external signal pressure piping.
- Mount cover (11) on the other side. Make sure that the vent plug points downwards when the control valve is installed to allow any condensed water that collects to drain off.

- | | |
|---------------------|--|
| 1 Lever | 12.1 Screw |
| 1.1 Nut | 12.2 Stopper or connection for external piping |
| 1.2 Disk spring | |
| 2 Follower pin | 13 Switch plate |
| 3 Follower clamp | 14 Gasket |
| 10 Cover plate | 15 Formed seal |
| 11 Cover | 16 Gasket |
| 12 Connection block | |

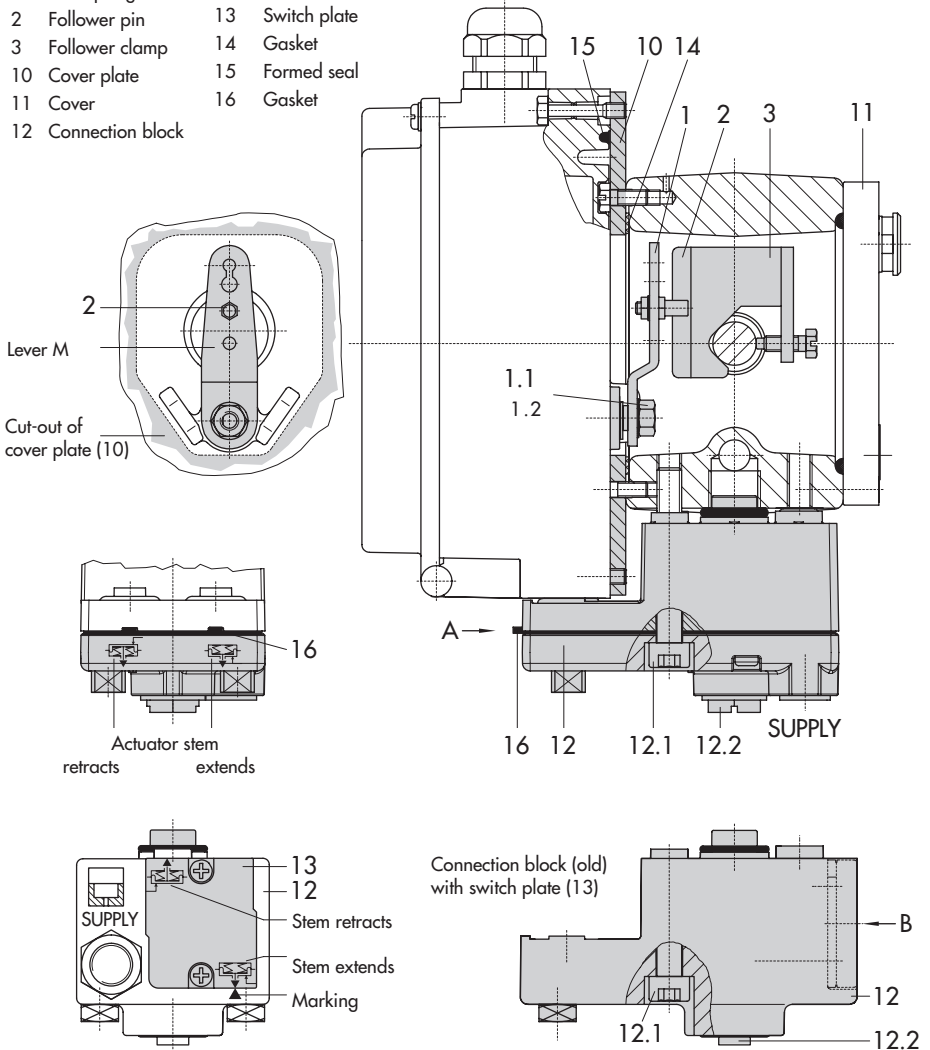

Fig. 4 · Direct attachment – Signal pressure connection for Type 3277 Actuator with 240, 350 and 700 cm²

2.2 Attachment according to IEC 60534-6

The positioner is attached to the control valve with a NAMUR bracket (10).

Refer to Table 3 on page 15 for the required mounting parts as well as the accessories with their order numbers.

Note the travel table on page 13!

1. Screw the two bolts (14) to the bracket (9.1) of the stem connector (9), place the follower plate (3) on top and use the screws (14.1) to tighten.

Actuator size 2800 cm²:

For a travel of 60 mm or smaller, screw the longer follower plate (3.1) directly to the stem connector (9). For a travel exceeding 60 mm, mount the bracket (16) first and then the follower plate (3) to the bracket together with the bolts (14) and screws (14.1).

2. Mount NAMUR bracket (10) to the control valve as follows:

For attachment to the NAMUR rib, use an M8 screw (11) and toothed lock washer directly in the yoke bore.

For attachment to valves with rod-type yokes, use two U-bolts (15) around the yoke.

Align the NAMUR bracket (10) in such a way that the slot of the follower plate (3) is centrally aligned with the NAMUR bracket at mid valve travel.

3. Mount connecting plate (6) or pressure gauge bracket (7) with pressure gauges

(8) on the positioner, making sure both seal rings (6.1) are seated properly.

4. Select required lever size (1) **M**, **L** or **XL** and pin position according to the actuator size and valve travels listed in the table below.

Should you require a pin position other than position **35** with the standard installed lever **M**, or require a lever size **L** or **XL**, proceed as follows:

5. Screw the follower pin (2) in the assigned lever bore (pin position) as listed in the table. Only use the longer follower pin (2) included in the mounting kit.
6. Place lever (1) on the positioner shaft and screw tight using the disk spring (1.2) and nut (1.1).

Note!

If you have mounted a new lever (1), you must move it once all the way as far as it will go in both directions.

7. Place positioner on the NAMUR bracket in such a manner that the follower pin (2) rests in the slot of the follower plate (3, 3.1). Adjust the lever (1) correspondingly.

Screw the positioner to the NAMUR bracket using both its fixing screws.

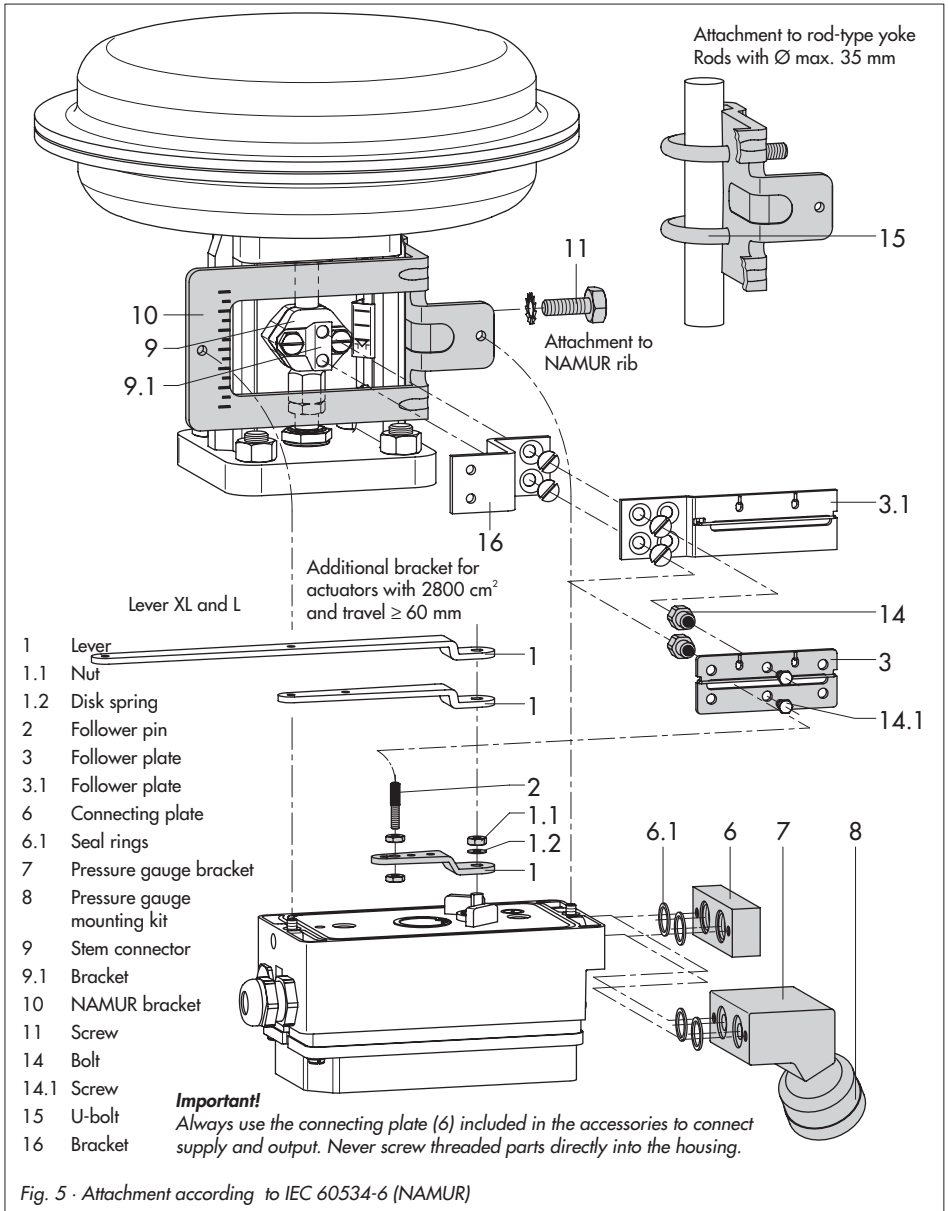

Fig. 5 · Attachment according to IEC 60534-6 (NAMUR)

2.3 Attachment to Type 3510 Micro-flow Valve

The positioner is attached to the valve yoke using a bracket.

Refer to Table 3 on page 15 for the required mounting parts as well as the accessories with their order numbers.

Note the travel table on page 13!

1. Place clamp (3) on the valve stem connector, align at a right angle and screw tight.
2. Screw bracket (10) to the valve yoke using two screws (11).
3. Mount connecting plate (6) or pressure gauge bracket (7) with pressure gauges to the positioner, making sure both seal rings (6.1) are seated properly.
4. Unscrew the standard installed lever **M** (1) including follower pin (2) from the positioner shaft.
5. Take lever **S** (1) and screw follower pin (2) in the bore for pin position **17**.
6. Place lever **S** on the positioner shaft and screw tight using the disk spring (1.2) and nut (1.1).
Move lever once all the way as far as it will go in both directions.
7. Place positioner on the bracket (10) in such a manner that the follower pin slides into the groove of the clamp (3). Adjust the lever (1) correspondingly. Screw the positioner to the bracket (10) using both its hexagon screws.

- 1 Lever
- 1.1 Nut
- 1.2 Disk spring
- 2 Follower pin
- 3 Clamp
- 6 Connecting clamp
- 6.1 Seal rings
- 7 Pressure gauge bracket
- 8 Pressure gauge mounting kit
- 10 Bracket
- 11 Screw

Important!
 Always use the connecting plate (6) included in the accessories to connect supply and output.
 Never screw threaded parts directly into the housing.

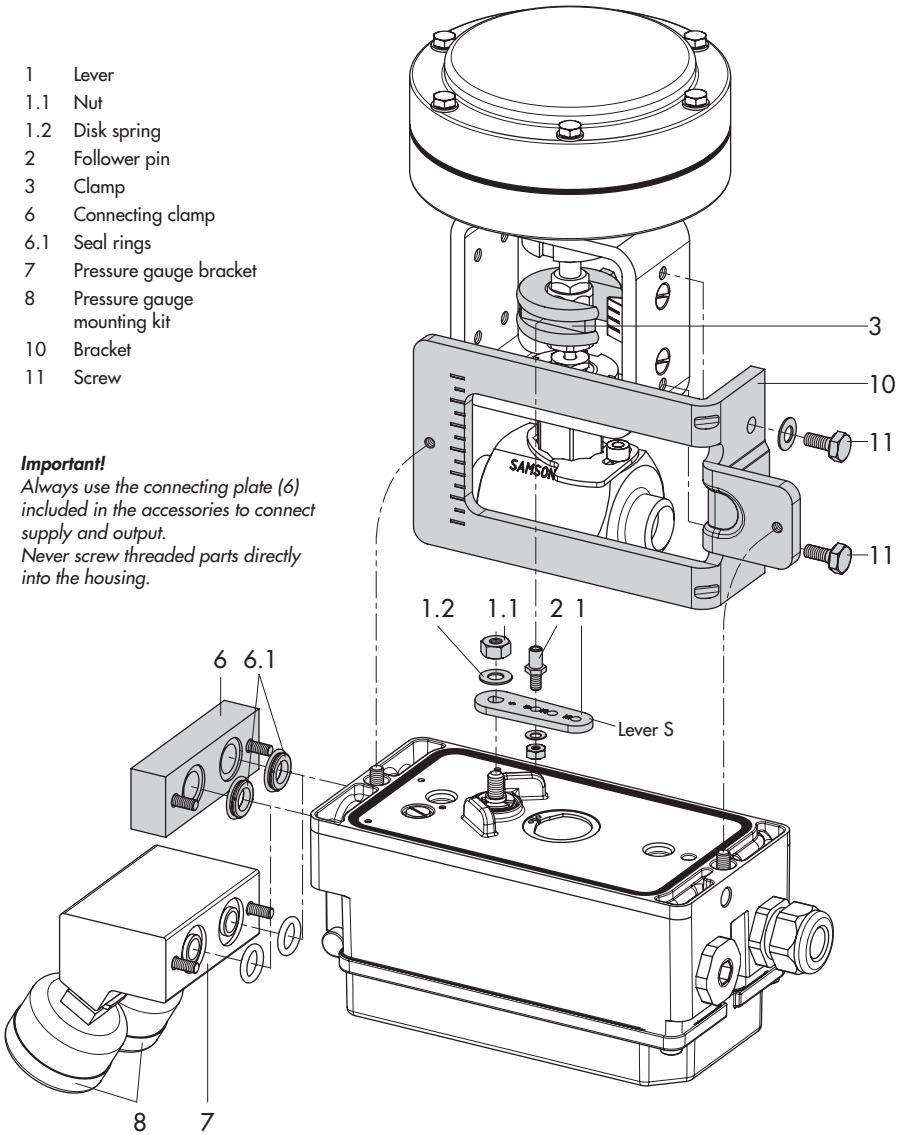

Fig. 6 · Attachment to Type 3510 Micro-flow Valve

2.4 Attachment to rotary actuators

The positioner is mounted to the rotary actuator using two pairs of double brackets.

Refer to Table 4 on page 15 for the required mounting parts as well as the accessories with their order numbers.

Prior to the attachment of the positioner to the SAMSON Type 3278 Rotary Actuator, you have to mount the associated adapter (5) to the free end of the rotary actuator shaft.

Note!

During the installation of the positioner as described below, it is imperative that the actuator's direction of rotation be observed.

1. Place follower clamp (3) on the slotted actuator shaft or the adapter (5).
2. Place coupling wheel (4) with flat side facing the actuator on the follower clamp (3). Refer to Fig. 8 to align slot so that it matches the direction of rotation when the valve is in its closed position.
3. Screw coupling wheel and follower clamp tightly onto the actuator shaft using screw (4.1) and disk spring (4.2).
4. Screw the bottom pair of brackets (10.1) with the bends pointing either to the inside or to the outside (depending on the actuator size) to the actuator case. Position top pair of brackets (10) and screw tight.

5. Mount connecting plate (6) or pressure gauge bracket (7) with pressure gauges to the positioner, making sure both O-rings are seated properly. For **double-acting**, springless rotary actuators, a reversing amplifier is required to attach the positioner to the actuator, see section 2.5.
6. Unscrew the standard follower pin (2) from the positioner's lever **M** (1). Use the metal follower pin ($\varnothing 5$) included in the mounting kit and screw tight into the bore for pin position 90° .
7. Place positioner on the top pair of brackets (10) and screw tight. Considering the actuator's direction of rotation, adjust lever (1) so that it engages in the slot of the coupling wheel (4) with its follower pin (see Fig. 8). It must be guaranteed that the lever (1) is parallel to the long side of the positioner when the actuator is at half its angle of rotation.
8. Stick scale plate (4.3) on the coupling wheel so that the arrow tip indicates the closed position, and it can be easily read when the valve is installed.

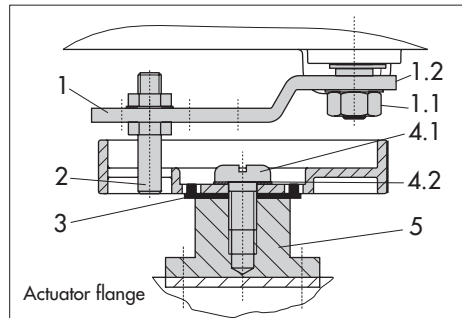
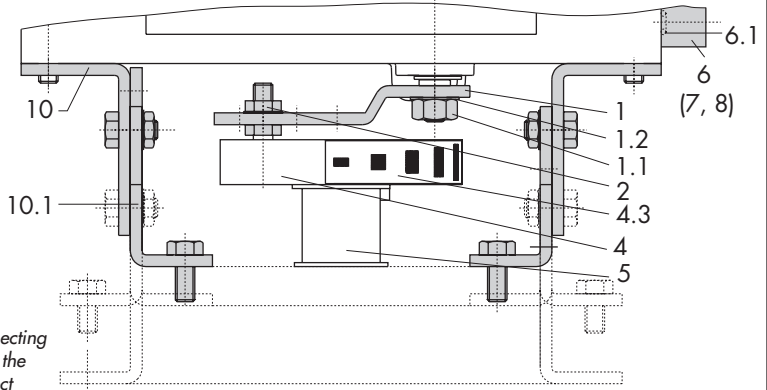
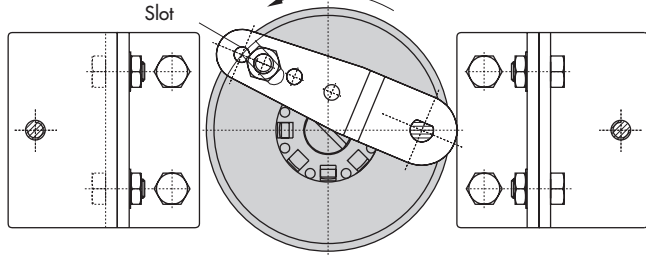

Fig. 7 · Mounting the coupling wheel with Type 3278



Important!
 Always use the connecting plate (6) included in the accessories to connect supply and output.
 Never screw threaded parts directly into the housing.

Control valve opens counterclockwise



Control valve opens clockwise

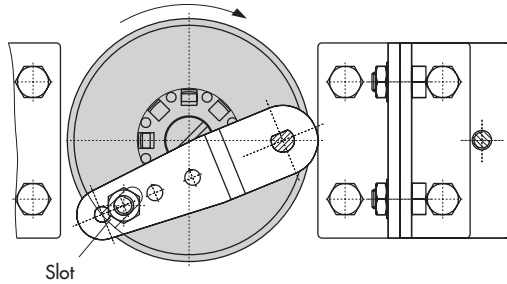

Legends Figs. 7 and 8

- 1 Lever
- 1.1 Nut
- 1.2 Disk spring
- 2 Follower pin
- 3 Follower clamp (Fig. 7)
- 4 Coupling wheel
- 4.1 Screw
- 4.2 Disk spring
- 4.3 Scale plate
- 4.3 Scale plate
- 5 Actuator shaft
Adapter for Type 3278
- 6.1 Seal rings
- 7 Pressure gauge bracket
- 8 Pressure gauge mounting kit
- 10 Top pair of brackets
- 10.1 Bottom pair of brackets

Fig. 8 - Attachment to rotary actuators

2.5 Reversing amplifier for double-acting actuators

For the use with double-acting actuators, the positioner must be fitted with a reversing amplifier. The reversing amplifier is listed as an accessory in the Table 5 on page 15.

The output signal pressure of the positioner is supplied at the output **A₁** of the reversing amplifier. An opposing pressure, which equals the required supply pressure when added to the pressure at **A₁**, is applied at output **A₂**.

The rule **A₁ + A₂ = Z** applies.

Mounting

1. Mount the connecting plate (6) from the accessories in Table 5 to the positioner. Make sure that both O-rings (6.1) are seated correctly.
2. Thread the special nuts (1.3) from the accessories of the reversing amplifier into the boreholes of the connecting plate.
3. Insert the gasket (1.2) into the recess of the reversing amplifier and push both the hollowed special screws (1.1) into the connecting boreholes **A₁** and **Z**.
4. Place the reversing amplifier onto the connecting plate (6) and screw tight using both the special screws (1.1).
5. Use a screwdriver (8 mm wide) to screw the enclosed filters (1.6) into the connecting boreholes **A₁** and **Z**.

Note!

The sealing plug (1.5) in the Type 3730 Positioner should not be unscrewed out of the reversing amplifier.

The rubber seal (1.4) is not required and can be removed when the sealing plug is used.

Signal pressure connections

A₁: Output **A₁** leading to the signal pressure connection at the actuator which opens the valve when the pressure increases

A₂: Output **A₂** leading to the signal pressure connection at the actuator which closes the valve when the pressure increases

- ▶ Set slide switch on positioner to **AIR TO OPEN**.

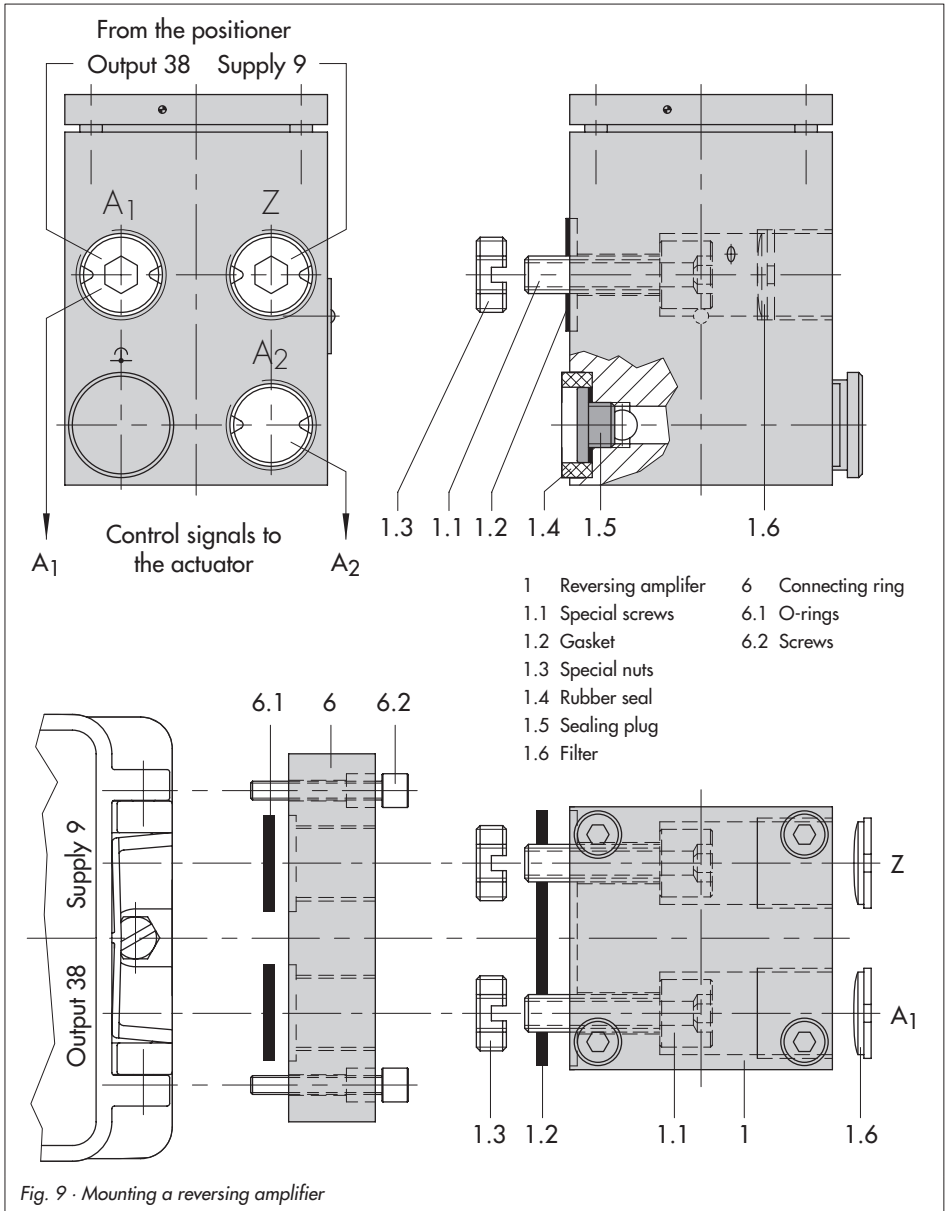

2.6 Attaching an external position sensor

Refer to Table 6 on page 33 for a list of the mounting parts as well as the accessories required for mounting the position sensor.

Accessories for the pneumatic connection to the positioner housing can be found in Table 7.

In the positioner version with an external position sensor, the sensor placed in a separate housing is attached over a plate or bracket to the control valve. The travel pick-off corresponds to that of a standard device.

The positioner unit can be mounted as required to a wall or a pipe.

For the pneumatic connection either a connecting plate (6) or a pressure gauge bracket (7) must be fixed to the housing, depending on the accessory chosen. Make sure the seal rings (6.1) are correctly inserted (see Fig. 5, bottom right).

For the electric connection the connecting lead must be fitted with an M12x1 connector plug at one end. The lead end without the plug can be shortened, if required, and wired to the connector included (section 3.2 on page 35). The electrical and pneumatic connections between the sensor and the positioner unit may be a maximum of 10 meters.

Note! In addition, the instructions in section 3.1 and 3.2 apply for the pneumatic and electrical connection.

Operation and setting are described in sections 4 and 5.

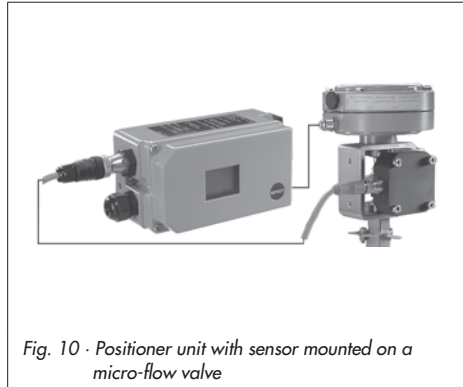

Fig. 10 · Positioner unit with sensor mounted on a micro-flow valve

2.6.1 Mounting the position sensor with direct attachment

Type 3277-5 Actuator with 120 cm²

The signal pressure from the positioner is routed over the signal pressure connection of the connecting plate (9, Fig. 11 left) to the actuator diaphragm chamber. To proceed, first screw the connecting plate (9) included in the accessories onto the actuator yoke.

- ▶ Turn the connecting plate (9) so that the correct symbol for the fail-safe position "Actuator stem extends" or "Actuator stem retracts" is aligned with the marking (Fig. 11, below).
- ▶ Make sure that the gasket for the connecting plate (9) is correctly inserted.
- ▶ The connecting plate has boreholes with NPT and G threads.
Seal the threaded connection that is not used with the rubber seal and square plug.

Type 3277 Actuator with 240 to 700 cm²:

The signal pressure is routed to the connection at the side of the actuator yoke for the version "Actuator stem extends".

For the fail-safe position "Actuator stem retracts" the connection on the top diaphragm case is used. The connection at the side of the yoke must be fitted with a venting plug (accessories).

Mounting the position sensor

1. Place the lever (1) on the sensor in mid-position and hold it in place. Unthread the nut (1.1) and remove the lever together with the disk spring (1.2) from the sensor shaft.

2. Screw the position sensor (20) onto the mounting plate (21).
3. Depending on the actuator size and rated travel of the valve, determine the required lever and position of the follower pin (2) from the travel table on page 13. The positioner is delivered with lever **M** in pin position **35** on the sensor. If necessary, remove the follower pin (2) from its pin position and move it to the bore-hole for the recommended pin position and screw tight.
4. Place the lever (1) and disk spring (1.2) on the sensor shaft.

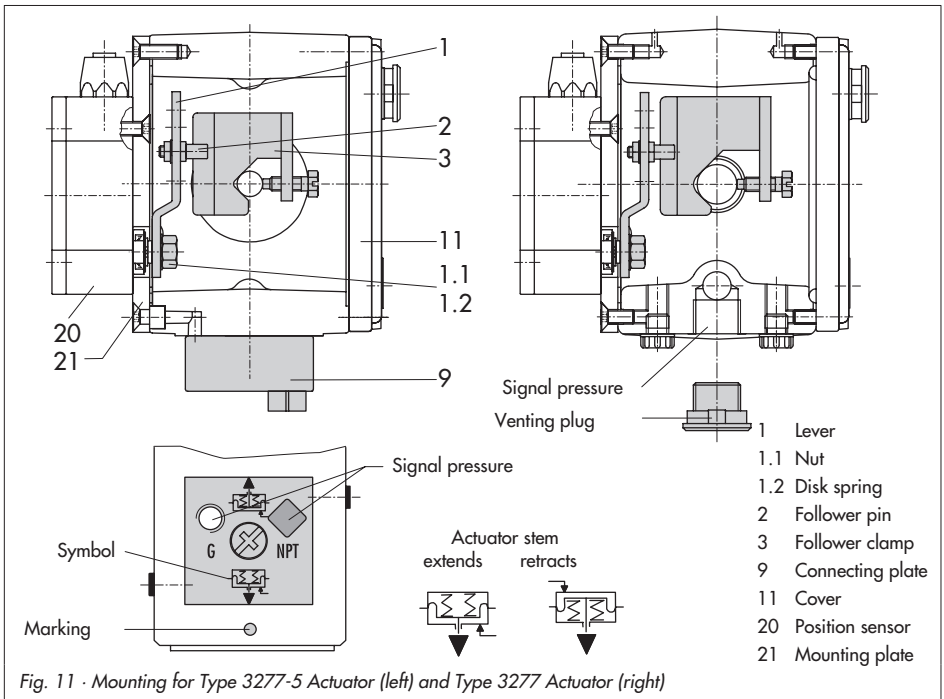

Place the lever (1) **in mid-position** and **hold it in place**. Screw on the nut (1.1).

5. Place the follower clamp (3) on the actuator stem, align and fasten it, making sure that the fastening screw rests in the groove of the actuator stem.
6. Place the mounting plate (21) together with the sensor onto the actuator yoke so that the follower pin (2) rests on the top of the follower clamp (3). It must rest on it with spring force. Screw tight the mounting plate (21) onto the actuator yoke using both fixing screws.
7. Mount cover (11) on the other side. Make sure that the vent plug points downwards when the control valve is installed to allow any condensed water that collects to drain off.

2.6.2 Mounting the position sensor with attachment according to IEC 60534-6

For the required mounting parts as well as the accessories, refer to the order numbers listed in Tables 6 and 7 on page 33.

1. Place the lever (1) on the sensor **in mid-position** and **hold it in place**. Unthread the nut (1.1) and remove the lever together with the disk spring (1.2) from the sensor shaft.
2. Screw the position sensor (20) onto the bracket (21).

The standard attached lever **M** with the follower pin (2) at position **35** is designed for 120, 240 and 350 cm² actuators with 15 mm rated travel.

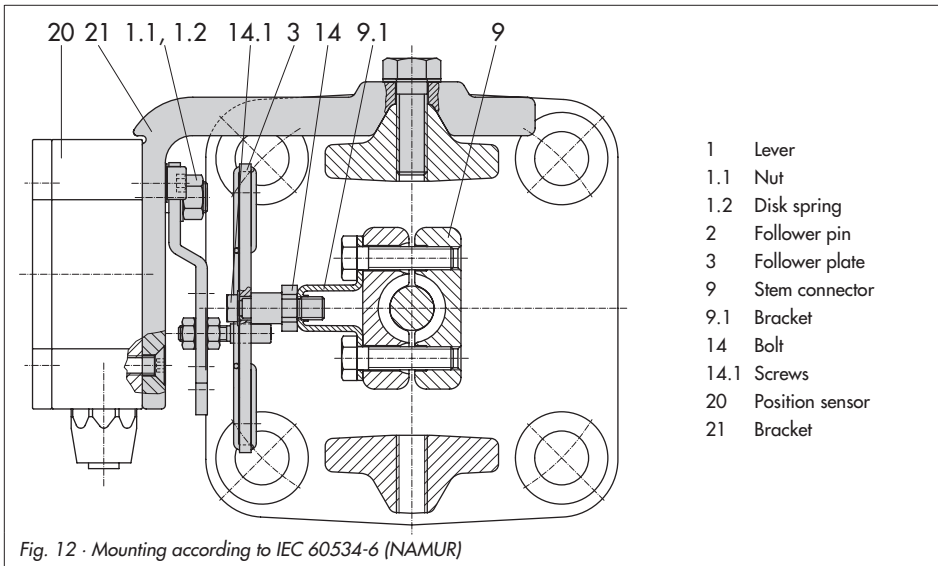

- | | |
|------|-----------------|
| 1 | Lever |
| 1.1 | Nut |
| 1.2 | Disk spring |
| 2 | Follower pin |
| 3 | Follower plate |
| 9 | Stem connector |
| 9.1 | Bracket |
| 14 | Bolt |
| 14.1 | Screws |
| 20 | Position sensor |
| 21 | Bracket |

For other actuator sizes or travels, select the lever and pin position from the travel table on page 13. Lever **L** and **XL** are included in the mounting kit.

- Place the lever (1) and disk spring (1.2) on the sensor shaft.
Place the lever (1) **in mid-position** and **hold it in place**. Screw on the nut (1.1).
- Screw both bolts (14) to the bracket (9.1) of the stem connector (9). Attach the follower plate (3) and fix with the screws (14.1).
- Place the bracket with the sensor at the NAMUR rib in such a manner that the follower pin (2) rests in the slot of the follower plate (3), then screw the bracket using its fixing screws onto the valve.

2.6.3 Mounting the position sensor to Type 3510 Micro-flow Valve

For the required mounting parts as well as the accessories, refer to the order numbers listed in Tables 6 and 7 on page 33.

- Place the lever (1) **in mid-position** and **hold it in place**. Unscrew the nut (1.1) and remove the standard attached lever **M** (1) together with the disk spring (1.2) from the sensor shaft.
- Screw the position sensor (20) onto the bracket (21).
- Select the lever **S** (1) from the accessories and screw the follower pin (2) into the hole for pin position **17**.
Place the lever (1) and disk spring (1.2) on the sensor shaft.

- Place the lever (1) in mid-position and hold it in place. Screw on the nut (1.1).
- Place the follower clamp (3) on the stem connector, align it at a right angle and screw tight.
- Position the bracket (21) with the position sensor on the valve yoke and screw tight, making sure the follower pin (2) slides into the groove of the follower clamp (3).

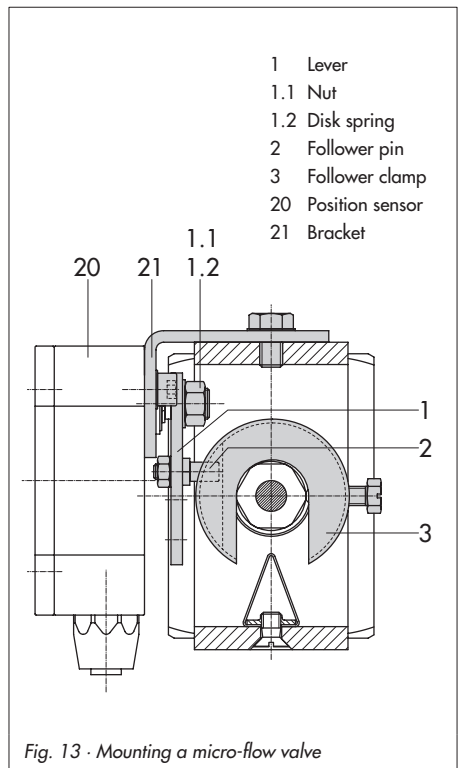

2.6.4 Mounting the position sensor to rotary actuators

For the required mounting parts as well as the accessories, refer to the order numbers listed in Tables 6 and 7 on page 33.

1. Place the lever (1) **in mid-position** and **hold it in place**. Unscrew the nut (1.1) and remove the standard attached lever **M** (1) together with the disk spring (1.2) from the sensor shaft.
2. Screw the position sensor (20) onto the bracket (21).
3. Replace the follower pin (2) normally attached to the lever (1) with the metal follower pin ($\varnothing 5$) from the accessories and screw it into the hole for pin position 90° .

4. Place the lever (1) and disk spring (1.2) on the sensor shaft.
Place the lever (1) **in mid-position** and **hold it in place**. Screw on the nut (1.1).

Follow the instructions describing attachment to the standard positioner in section 2.4. Instead of the positioner, attach the position sensor (20) with its mounting plate (21).

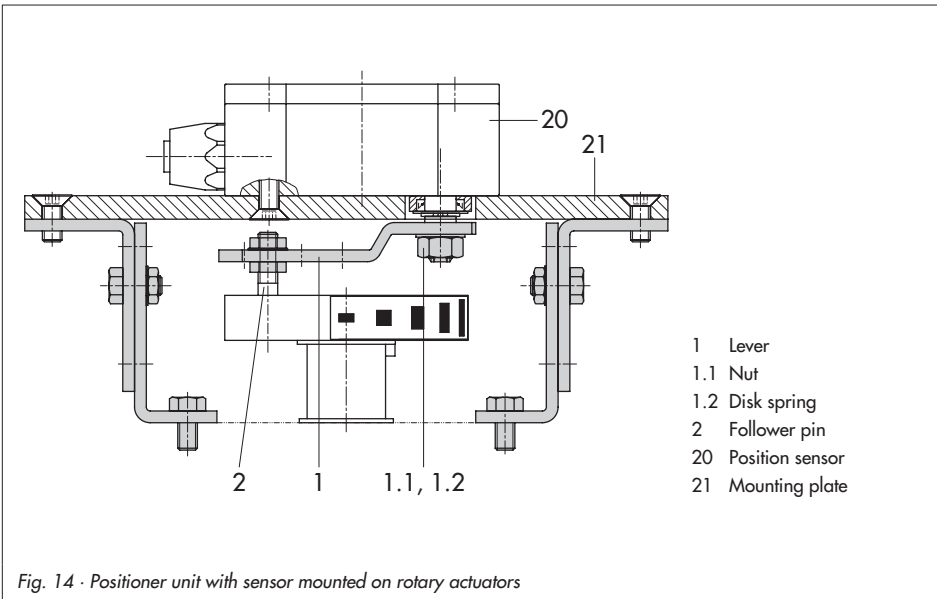

Fig. 14 - Positioner unit with sensor mounted on rotary actuators

Table 6		Mounting parts for position sensor	Order no.
Direct attachment	Mounting parts for actuators with 120 cm ² see Fig. 11 left		1400-7472
Accessories for actuator 120 cm ²	Connecting plate (9, old) for Actuator Type 3277-5xxxxx. 00	G 1/8 1/8 NPT	1400-6820 1400-6821
	Connecting plate (new) for Actuator Type 3277-5xxxxx. 01 (new)		1400-6823
	<i>Note: Only new switchover and connecting plates can be used with new actuators (Index 01). Old and new plates are not interchangeable.</i>		
Direct attachment	Mounting parts for actuators with 240, 350 and 700 cm ² , see Fig. 11 right		1400-7471
NAMUR attachment	Mounting parts for attachment to NAMUR rib w. lever L and XL, see Fig. 12		1400-7468
Attachment to micro-flow valves	Mounting parts for Type 3510 Micro-flow Valve, see Fig. 13		1400-7469
Attachment to rotary actuators	Mounting parts with follower clamp and coupling wheel, see Fig. 14		1400-7473
Table 7		Positioner accessories	Order no.
Accessories	Connecting plate (6)	G ¼ ¼ NPT	1400-7461 1400-7462
	or pressure gauge bracket (7)	G ¼ ¼ NPT	1400-7458 1400-7459
	Pressure gauge mounting kit (8) (output and supply)	St. steel/Brass St.st./St. steel	1400-6950 1400-6951

3 Connections

3.1 Pneumatic connections

Caution!

The threads in the positioner housing are not designed for direct air connection!

The screw glands must be screwed into the connecting plate, the pressure gauge mounting block or the connection block from the accessories. The air connections are optionally designed as a bore with ¼ NPT or G ¼ thread.

The customary fittings for metal and copper pipes or plastic hoses can be used.

Note!

The supply air must be dry and free from oil and dust. The maintenance instructions for upstream pressure reducing stations must be observed.

Blow through all air tubes and hoses thoroughly prior to connecting them.

If the positioner is attached directly to the Type 3277 Actuator, the connection of the positioner's output pressure to the actuator is fixed. For attachment according to IEC 60534-6 (NAMUR), the signal pressure can be routed to either the top or bottom diaphragm chamber of the actuator, depending on the actuator's fail-safe action "Actuator stem extends" or "Actuator stem retracts".

For rotary actuators, the manufacturer's specifications for connection apply.

3.1.1 Signal pressure gauges

To monitor the supply air (Supply) and signal pressure (Output), we recommend that pressure gauges be attached (see accessories in Tables 1 to 4).

3.1.2 Supply pressure

The required supply air pressure depends on the bench range and the actuator's operating direction (fail-safe action).

The bench range is registered on the nameplate either as spring range or signal pressure range depending on the actuator. The direction of action is marked **FA** or **FE**, or by a symbol.

Actuator stem extends FA (Air to open ATO)

Fail-safe position "Valve Closed"
(for globe and angle valves):

Required supply pressure = Upper bench range value + 0.2 bar, minimum 1.4 bar.

Actuator stem retracts FE (Air to close ATC)

Fail-safe position "Valve Open"
(for globe and angle valves):

For tight-closing valves, the maximum signal pressure $p_{st_{max}}$ is roughly estimated as follows:

$$p_{st_{max}} = F + \frac{d^2 \cdot \pi \cdot \Delta p}{4 \cdot A}$$

- d = Seat diameter [cm]
 Δp = Differential pressure across the valve
 [bar]
 A = Actuator diaphragm area [cm²]
 F = Upper bench range of the actuator
 [bar]

If there are no specifications, calculate as follows:

Required supply pressure =
 Upper bench range value + 1 bar

Note!

The signal pressure at the output (Output 38) of the positioner can be limited to 1.4, 2.4 or 3.7 bar over Code 16 or the pressure limit can be deactivated (MAX).

3.2 Electrical connections



For electrical installation, you are required to observe the relevant electrotechnical regulations and the accident prevention regulations that apply in the country of use. In Germany, these are the VDE regulations and the accident prevention regulations of the employers' liability insurance association.

The following standards apply for assembly and installation in hazardous areas: EN 60079-14: 2003 (VDE 0165 Part 1/8.98) "Electrical apparatus for explosive gas atmospheres" and EN 50281-1-2: 1999 (VDE 0165 Part 2/11.99) "Electrical apparatus for use in the presence of combustible dust".

For the interconnection of intrinsically safe electrical equipment, the permissible maximum values specified in the EC type examination certificate apply (U_i or U_0 ; I_i or I_0 ; P_i or P_0 ; C_i or C_0 , and L_i or L_0).

The following applies for equipment with type of protection EEx nA (non-sparking apparatus) according to the standard EN 50021 (1999): Connecting, interrupting, or switching circuits while energized is only allowed during installation, maintenance or repair work.

The following applies for equipment connected to energy-limited circuits with type of protection EEx nL (energy-limited apparatus) according to the standard EN 50021 (1999): This type of equipment may be switched under normal operating conditions.

For the interconnection of equipment to energy-limited circuits with type of protection EEx nL IIC, the permissible maximum values specified in the statement of conformity or the addenda to the statement of conformity apply.

Caution!

The terminal assignment specified in the certificate must be adhered to. Reversing the assignment of the electrical terminals may cause the explosion protection to become ineffective!

Do not tamper with enameled screws inside or on the housing.

Note on the selection of cables and wires:

To install intrinsically safe circuits, observe section 12 of the standard EN 60079-14: 2003 (VDE 0165 Part 1). To run multi-core cables or lines with more than one intrinsically safe circuit, section 12.2.2.7 of this standard applies.

An additional cable gland can be installed when connecting the device over two separate cables. Cable entries left unused must be sealed with blanking plugs. Devices used at ambient temperatures down to $-20\text{ }^{\circ}\text{C}$ must have metal cable entries.

The wires for the reference variable must be connected to the terminals 11 and 12 located in the housing. Only use a **current source!**

Caution!

The erroneous connection of a voltage source of just around 7 V (or around 2 V when connected to the wrong pole) can damage the positioner.

In general, it is not necessary to connect the positioner to a bonding conductor. Should this be required, however, this conductor can be connected inside the device.

Depending on the version, the positioner is equipped with inductive limit switches and/or a solenoid valve.

The position transmitter is operated on a two-wire circuit. The usual supply voltage is 24 V DC. Considering the resistance of the supply leads, the voltage at the position transmitter terminals can be between 12 and 30 V DC.

Refer to Fig. 15 or the label on the terminal strip for terminal assignment.

Note! The minimum permissible reference variable should not fall below 3.8 mA for operating the positioner.

Accessories:

Plastic cable gland M20 x 1.5:

Black Order no. 1400-6985

Blue Order no. 1400-6986

Nickel-plated brass Order no. 1890-4875

Adapter M20 x 1.5 to 1/2 NPT

Aluminum, powder-coated

Order no. 0310-2149

Connection for version with external position sensor

The terminal assignment is fixed by the connector of the connecting lead.

- ▶ Shorten the connecting lead to the required length and strip the insulation off. Route the strands to the following contacts of the free connector:

Contact	Cable color
1	Brown
2	White
3	Blue
4	Black shielding
5	Green/yellow

- ▶ Connect the fixed M12x1 plug connector to the position sensor and the mounted connector to the positioner unit.

3.2.1 Switching amplifiers

For operation of the limit switches, switching amplifiers must be connected in the output circuit. To ensure the operating reliability of the positioner, the amplifiers should comply with the limit values of the output circuits conforming to EN 60947-5-6.

If the positioner is to be installed in hazardous areas, the relevant regulations must be observed.

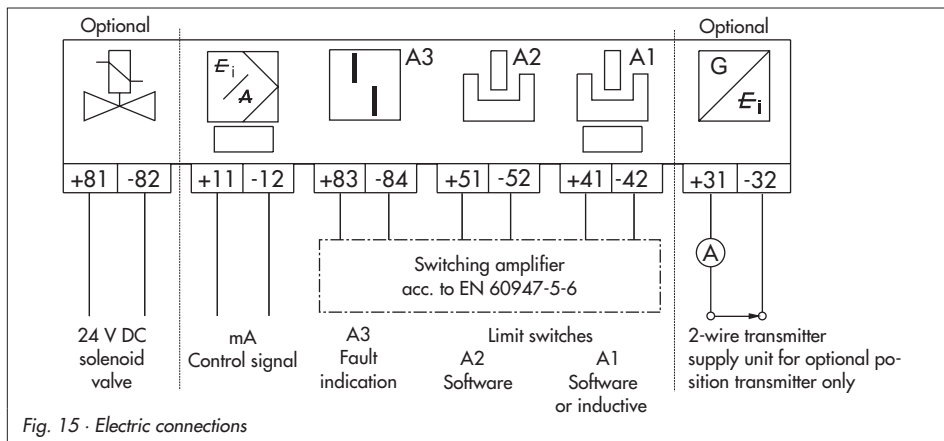

4 Operation

Note!

A summary about operating and start up can be found in section 8 on page 61. A leaflet including the same summary is also enclosed with the positioner.

4.1 Operator controls and display

Rotary pushbutton

The positioner is mainly operated with the rotary pushbutton.

Turn the  button to select and set codes, parameter and values. Press it to confirm them.

Slide switch AIR TO OPEN or AIR TO CLOSE

This switch is used to adapt the positioner to the operating direction of the actuator.

For actuator where the supply pressure opens the valve, fail-safe position: "springs close valve": switch position AIR TO OPEN.

For actuator where the supply pressure closes the valve, fail-safe position: "springs open valve": switch position AIR TO CLOSE.

For positioners with an attached reversing amplifier for double-acting rotary actuators (section 2.5): switch position AIR TO OPEN.

The switch position is prompted prior to an initialization. After an initialization has been completed, changing the switch position does not have any effect on the operation of the positioner.



Volume restriction Q

The volume restriction is used to adapt the air delivery to the actuator size. Two fixed settings are possible depending on how the air is routed at the actuator:

- ▶ For actuators smaller than 240 cm² with a loading pressure connection at the side (Type 3271-5), set restriction to MIN SIDE.
- ▶ For a connection at the back (Type 3277-5), set restriction to MIN BACK.
- ▶ For actuators 240 cm² and larger, set to MAX SIDE for a side connection and to MAX BACK for a connection at the back.

Displays

The LC display indicates symbols that are assigned to parameters, codes and functions.

The bar graph in the operating modes manual  and automatic  indicates the system deviation that depends on the sign (+/-) and the value. One bar graph element appears per 1 % system deviation.

If the device has not yet been initialized (see section 4.3.1), the lever position in degrees in relation to the longitudinal axis is indicated instead of the system deviation. One bar graph element corresponds to approximately a 5° angle of rotation.

If the fifth element blinks (value displayed > 30°), the permissible angle of rotation has been exceeded. Lever and pin position must be checked.

Displays and their meaning

AUTO	Automatic mode	MAX	Maximum range	TunE	Initialization in progress
CL	Clockwise	NO	Not available	YES	Available
CCL	Counterclockwise	NOM	Nominal travel	ZP	Zero calibration
Err	Error	ON	ON	↗↗	Increasing/increasing
ESC	Escape	OFF	OFF	↘↘	Increasing/decreasing
HI	ix greater than 21.6 mA	RES	Reset	↻	Blinking Controlled operation
LO	ix smaller than 2.4 mA	RUN	Start	↻	Blinking Not initialized
LOW	w too low	SAFE	Fail-safe position		
MAN	Manual mode	SUB	Substitute calibration		

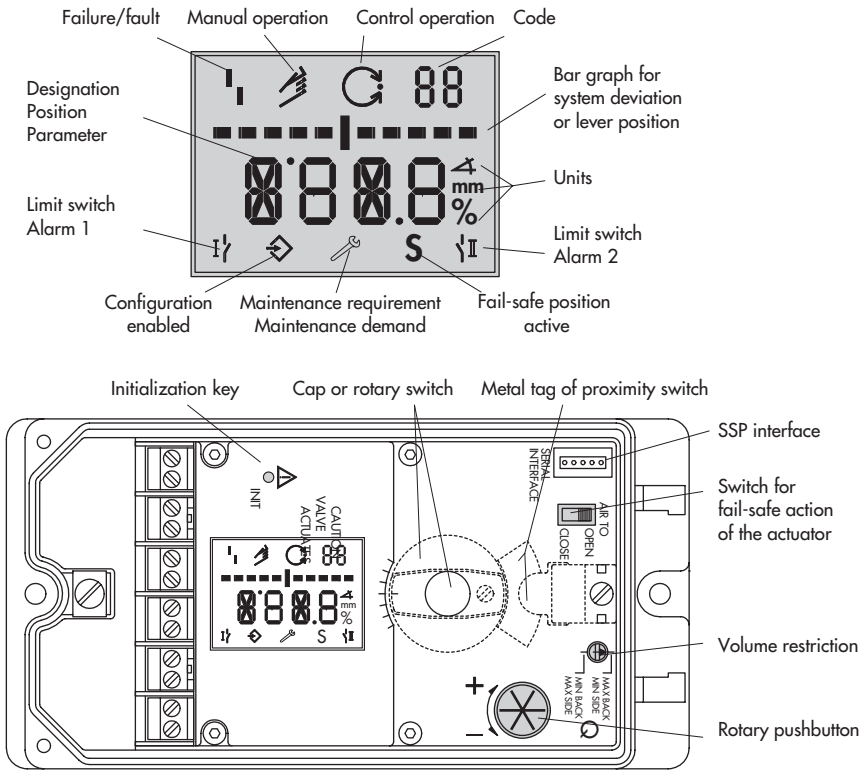
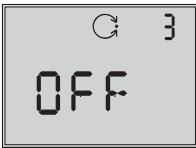

Fig. 16 · Display and operator controls

4.2 Enabling and selecting parameters



The codes which are marked with an asterisk (*) in section 12 on page 66 onwards must be enabled with Code 3 before the associated parameters can be configured as described below.





Code 3
Configuration
not enabled



Configuration
enabled

- ▶ From the current display, turn the rotary pushbutton until Code 3 and OFF appear on the display. Confirm Code 3 by pressing the  button, the code number blinks.
- ▶ Turn  button until ON appears. Confirm setting by pressing the  button.

Configuration is enabled and is indicated by  symbol appearing on the display.

Now you can adjust the codes, parameters and values for the control valve in any desired order by turning the  button. Confirm settings by pressing the  button.

Note!

To cancel a value that you have just entered under a code, turn the  button until ESC appears on the display and press to confirm.



Canceling the setting

Note! If no settings are entered within 120 seconds, the enabled configuration function becomes invalid and the display reverts to Code 0.

The code list on page 66 onwards in section 12 shows all parameters that can be adjusted, including their description and their default settings.

Important!

After attaching the positioner to the valve as well as setting the fail-safe position and the volume restriction, it is sufficient for standard operation to press the initialization key in order to ensure optimum positioner operation (section 5.5 on page 45).

For this purpose, the positioner must be operated with its default values. If necessary, a reset must be carried out (section 5.8 on page 54).

4.3 Operating modes

4.3.1 Automatic and manual operating modes

Prior to initialization:

If the positioner has not been initialized yet, the automatic operating **AUTO** cannot be selected.

The valve can only be positioned manually with the positioner.

To proceed, turn  button clockwise until Code **1** appears, then confirm Code **1** by pressing the  button.



If both the code number and the hand symbol are blinking, the valve can be manually positioned by turning the  button.

After initialization:

After successful initialization in the **MAX**, **NOM** or **MAN** mode (section 5.5.1), the positioner is in the automatic control operation mode .

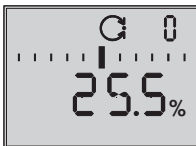

Standard

Switching to manual operating mode

Over Code **0**, press the  button, **AUTO** appears in the display, Code **0** blinks.

Turn  button until **MAN** appears.



Press  button to switchover to the manual operating mode .

The switchover is smooth since the manual operating mode starts up with the set point last used during automatic operating mode. The current position is displayed in %.

Adjusting the manual set point



Turn  button until Code **1** appears.

Press  button to confirm, Code **1** blinks. While Code **1** is blinking, you can move the valve to the position required by turning the button. To proceed, turn the button until enough the positioner has built up enough pressure and the control valve starts to react. The positioner automatically returns to manual mode with Code **0** if the button is not activated within two minutes.

Switching from manual to automatic operating mode works in the same manner.

First, you must reset the positioner to Code **0** and set it to automatic mode **AUTO** and confirm.

4.3.2 SAFE – Fail-safe position

If you want to move the valve to fail-safe position, proceed as follows:

Select Code **0**, press the  button, **AUTO** or **MAN** appears on the display, Code **0** blinks.

Turn the  button until **SAFE** appears.



Press the  button to confirm this setting.

*Operating mode **SAFE** has been selected, symbol **S** for the fail-safe position appears.*

Caution!

The valve moves to the fail-safe position.

Once the positioner is initialized, the current valve position is indicated on the digital display in %.

If you want to return the valve from the fail-safe position to the operating mode **AUTO** or **MAN**, the  button must be pressed while Code **0** is active.

When the code number blinks, turn the  button to switch to the desired operating mode.

Press the  button to confirm.

5 Start-up and settings

Note!

A summary about start-up and operation can be found in section 8 on page 61. A leaflet including the same summary is also enclosed with the positioner.

- ▶ Connect pneumatic supply air (Supply 9), making sure the pressure is correct as described in section 3.1.
- ▶ Apply an electrical reference variable of 4 to 20 mA (terminals 11 and 12).
- ▶ The voltage supply >19 V DC for version with a solenoid valve must be connected at terminals 81 (+) und 82 (-).



Warning!

The signal pressure supplied may cause the actuator stem to move, be aware of risk of injury!

5.1 Determining the fail-safe position

To adapt the positioner to the operating direction of the actuator, set slide switch to AIR TO OPEN or AIR TO CLOSE .

AIR TO OPEN = Signal pressure opens the valve, for fail-safe position: actuator stem extends/valve closed

AIR TO CLOSE = Signal pressure closes the valve, for fail-safe position: actuator stem retracts/valve open.

The switch position is prompted prior to an initialization. After an initialization has been completed, changing the switch position

does not have any effect on the operation of the positioner.

5.2 Setting the volume restriction Q

- ▶ For actuators smaller than 240 cm² with a loading pressure connection at the side (Type 3271-5), set restriction to MIN SIDE.
- ▶ For a connection at the back (Type 3277-5), set restriction to MIN BACK.
- ▶ For actuators 240 cm² and larger, set to MAX SIDE for a side connection and to MAX BACK for a connection at the back.

Note! The positioner must re-initialized if the volume restriction setting is changed after the positioner has already been initialized.

Adapting the display

The data representation on the positioner display can be turned by 180°. If the displayed data appear upside down, proceed as follows:



Reading direction for right attachment of pneumatic connections



Reading direction for left attachment of pneumatic connections

Turn the button until Code 2 appears, and press the button to confirm Code 2, Code 2 blinks.

- ▶ Turn button until the display is adjusted to the desired direction, then confirm reading direction by pressing the button.

5.3 Limiting the signal pressure

If the maximum actuator force may cause damage to the valve, the signal pressure must be limited. Select Code 3 to enable configuration and then access Code 16 to set the pressure limit to 1.4, 2.4 or 3.7 bar. The pressure limit required is only automatically determined during initialization when the fail-safe position is set to AIR TO OPEN.

5.4 Checking the operating range of the positioner

To check the mechanical attachment and the proper functioning, the valve should be moved through the operating range of the positioner in the manual operating mode with the manual reference variable.



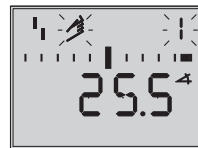

Code 0
Select manual operation
Default **MAN**



Code 1
Position valve using the rotary pushbutton, the current angle of rotation is indicated

1. Turn the button until Code 0 appears, then confirm Code 0 by pressing the button.
2. Turn the button until **MAN** appears in the display, i.e. manual operating mode,

confirm selected operating mode by pressing the  button.

3. Turn the  button until Code **1** appears, confirm Code **1** by pressing  button. The hand symbol and Code **1** blink.
4. Position control valve by turning the  button several times until pressure builds up, and the control valve moves to its final positions so that the travel/angle of rotation can be checked.

The permissible range has been exceeded when the displayed angle is higher than 30°, and the outer right or left bar graph element blinks.

If this is the case, it is absolutely necessary to check lever and pin position as described in section 2.

Note!

*If the selected pin position is smaller than intended for the respective travel range, the positioner switches to the **SAFE** mode, the valve moves to the fail-safe position (see section 4.3.2 on page 42).*

5. Initialize positioner as described in section 5.5.

Simplified start-up!

For most applications, the positioner with its default settings is ready for operation, provided it has been properly attached.

After the fail-safe position and the volume restriction have been set, the positioner only needs to be initialized by pressing the INIT key.

Caution!

Prior to starting the initialization procedure, check the maximum permissible supply pressure of the control valve to prevent the valve from being damaged. On initialization, the positioner supplies the maximum available supply pressure. If necessary, restrict the signal pressure by using a pressure reducing valve upstream of the control valve.

*Initialization is run in default mode **MAX** (section 5.5.1). During this process, the positioner adapts itself optimally to the maximum travel/angle of rotation range. The only parameter that must be checked is the direction of action, i.e. whether the default setting (Code **7** to **↗** = increasing/increasing) matches the application or whether it must be changed.*

The initialization modes described in following serve to individually adapt and optimize the positioner to the way it is attached to the valve.

5.5 Initialization



During initialization the positioner adapts itself optimally to the friction conditions and the signal pressure demand of the control valve.

The type and extent of self-adaptation depends on the set initialization mode (see section 5.5.1).

MAX is the default setting for initialization based on the maximum nominal range.

If configuration is enabled via Code **3**, Code **6** can be used to change to other initialization modes.

If the positioner has been initialized once already, it will automatically go to the operating mode used last after the electrical reference variable is applied, Code **0** appears on the display.

If the positioner has not yet been initialized, the fault symbol  appears on the display and the hand symbol  blinks.

Note!

Every time you re-initialize the positioner, it should be reset to its basic setting including the default values. Refer to section 5.8 on page 54.

- ▶ **Start the initialization process by pressing the INIT key with a suitable tool.**

The time required for an initialization process depends on the transit time of the actuator and take several minutes.

Positioners with EXPERT+ diagnostic functions start plotting the reference graphs after

the initialization process has been completed. See note at the end of this section.



Warning!

During initialization, the control valve moves through its entire travel/angle of rotation range. Therefore, do not start initialization while a process is running, but only during start-up, when all shut-off valves are closed.

Note! The initialization procedure can be canceled while running by pressing . **STOP** appears three seconds long and the positioner then moves to the fail-safe position.



Alternating displays
Initialization running



Bar graph display
indicating the progress of
the initialization



Initialization successful,
positioner in automatic
operating mode

After a successful initialization, the positioner runs in control operation indicated by the  control symbol.

The control position in % predetermined by the reference variable appears on the display.

A malfunctioning leads to the process being canceled automatically. The initialization error appears on the display according to how it has been classified by the condensed status. See section 5.6 on page 53.

If the slide switch is set to AIR TO CLOSE, the positioner automatically switches to the direction of action increasing/decreasing (↗↘) on successful completion of initialization. This results in the following assignment between reference variable and valve position:

Fail-safe position	Direction of action	Valve	
		Closed at	Open at
Actuator stem extends FA AIR TO OPEN	↗↗	4 mA	20 mA
Actuator stem retracts FE AIR TO CLOSE	↗↘	20 mA	4 mA

The tight-closing function is activated. Set Code **15** (final position $w>$) to 99 % for three-way valves. Further settings relevant for the valve can be entered subsequently.

Note!

Positioner with integrated EXPERT+ diagnostics automatically start to plot the reference graphs (drive signal Y d1 and hysteresis d2) after initialization has been completed. TEST d1 and d2 appear on the display in an alternating sequence.

An unsuccessful plotting of the reference graphs are indicated on the display by Code 81 (see error code list). After the initialization has been successfully completed, the positioner still works properly, even though the reference graph plotting has not been completed successfully.

The reference graphs are required for the extended diagnostic functions of EXPERT+.

5.5.1 Initialization modes

After enabling configuration with Code **3** and accessing Code **6**, you can choose one of the initialization modes **MAX**, **NOM**, **MAN** or **SUB** to start initialization. **ZP**, the zero calibration is described in section 5.7 on page 54.

MAX – Initialization based on maximum range

Initialization mode for simplified start-up for valves with two clearly defined mechanical travel stops, e.g. three-way valves.

The positioner determines travel/angle of rotation of the closing member from the CLOSED position to the opposite side and adopts this travel/angle of rotation as the operating range from 0 to 100 %.

Enable configuration:



Default **OFF**

Turn \otimes → Code **3**, press \otimes ,

Turn \otimes → ON, press \otimes .

After enabling:

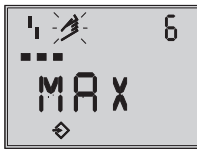

Default **MAX**

Turn \otimes → Code **6**, press \otimes ,

Turn \otimes → MAX, press \otimes .

► **Press INIT key to start initialization!**



The initialization procedure may take several minutes, depending on the actuator size, as the valve moves through its entire travel/angle of rotation range.

Positioners with EXPERT+ diagnostic functions automatically start plotting the reference graphs after the initialization process has been completed. See section 5.5.

Note!

For **MAX** initialization, the positioner cannot indicate nominal travel/angle of rotation in mm/°, Code **5** remains disabled.

In addition, the lower (Code **8**) and the upper (Code **9**) x-range value can only be displayed and modified in %.

During **MAX** initialization, an increased system deviation (undefined final position of the actuator) in the upper control range may occur with some control valves due to the pneumatic actuator design.

If you want the display to indicate mm/°, proceed as follows after configuration has been enabled:

Turn \otimes → Code **4**, press \otimes ,

turn \otimes → Select pin position entered during installation, press \otimes .

If you now switch to Code **5**, the nominal range appears in mm/°.

The lower and upper x-range values for Code **8** and **9** are displayed in mm/° and can be adapted accordingly.

NOM – Initialization based on nominal range

Initialization mode for globe valves, especially for valves with maximum ranges that are clearly greater than the required nominal range.

For this initialization mode, the following parameters must be entered: pin position (Code **4**), nominal travel/angle (Code **5**) and, if required, the direction of action (Code **7**).

The calibrated sensor enables the effective valve travel to be preset very accurately.

During the initialization procedure, the positioner checks whether the control valve can move through the indicated nominal range (travel or angle) without collision. In case of a positive result, the indicated nominal range is adopted with the limits of lower x-range and upper x-range values as the operating range.

Note!

The maximum possible travel must always be greater than the nominal travel entered. If this is not the case, the initialization is canceled (error indication Code 52) because the nominal travel is not achieved.

Enable configuration:



Default **OFF**

Turn → Code **3**, press ,
turn → ON, press .

After enabling:

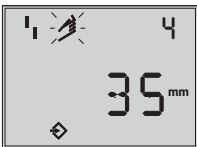

Default **OFF**

Turn → Code **4**, press ,
turn → Select pin position entered during installation, press .



Default **15**

Turn → Code **5**, press ,
turn → Enter nominal valve travel,
press .

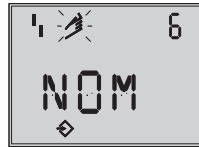

Default **MAX**

Turn → Code **6**, press ,
turn → **NOM**, press .

▶ **Press INIT key to start initialization!**



The initialization procedure may take several minutes, depending on the actuator size, as the valve moves through its entire travel/angle of rotation range.

Positioners with EXPERT+ diagnostic functions automatically start plotting the reference graphs after the initialization process has been completed. See note at the bottom of page 46.

MAN – Initialization based on a manually selected range

(with default upper x-range value by means of manual adjustment).

Initialization mode just as **NOM**, however, for starting up valves with unknown nominal range.

In this mode, the positioner expects the control valve to be moved manually to the desired OPEN position prior to enabling the initialization procedure.

The upper range travel/angle of rotation value is adjusted using the rotary pushbutton. The positioner uses this OPEN position and the CLOSED position to calculate the differential travel/angle and accepts it as the operating range with the lower x-range value and upper x-range value being the limits.

Enable configuration:



Default **OFF**

Turn → Code **3**, press .

turn → **ON**, press .

After enabling:

Turn → Code **4**, press .

turn → Select pin position entered during installation, press .

Turn → Code **6**, press .

turn → **MAN**, press .



Default **MAX**

Turn → Code **0**, press .

turn → **MAN**, press .



Default **MAN**

Turn → Code **1**, press .

Code 1 blinks.



Turn until the valve reaches its OPEN position, press .

▶ Press INIT key to start initialization!



The initialization procedure may take several minutes, depending on the actuator size, as the valve moves through its entire travel/angle of rotation range.

Positioners with EXPERT+ diagnostic functions automatically start plotting the reference graphs after the initialization process has been completed. See note at the bottom of page 46.

SUB

(substitute configuration, without initialization)

This initialization mode is an emergency mode. The positioner parameters are estimated and not determined by an initialization procedure, so that a high stationary accuracy cannot be expected.

You should always select a different initialization mode if the plant allows it.

The initialization mode **SUB** is used to replace a positioner while the process is in operation. For this purpose, the control valve is usually fixed mechanically in a certain position, or pneumatically by means of a pressure signal which is routed to the actuator externally. The blocking position ensures that the plant continues to operate with this valve position.

The spare positioner should not be initialized. If necessary, reset the spare positioner using Code **36**.

After the old positioner has been replaced with a new one, the following parameters must be entered: pin position (Code **4**), nominal range (Code **5**), direction of action (Code **7**) and closing direction (Code **34**).

The default travel limit of 100 % (Code **11**) must be disabled with **OFF**.

In addition, the blocking position (Code **35**) must be adjusted with the \otimes button so that it matches the position of the previously blocked valve.

The parameters K_p (Code **17**), T_v (Code **18**) and the pressure limit (Code **16**) should remain set to their default values. If the configuration data of the new positioner are known, it is recommended to accept its K_p and T_v values.

After setting the AIR TO OPEN/CLOSE switch for the fail-safe position, setting the volume restriction and pressing the INIT key, the positioner calculates its configuration data on the basis of the blocking position and the closing direction as well as the other entered data.

The positioner switches to manual operation, subsequently the blocking position should be canceled as described on page 52.

Enable configuration:

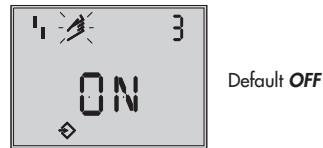

Turn \otimes → Code **3**, press \otimes ,
turn \otimes → **ON**, press \otimes .

After enabling:

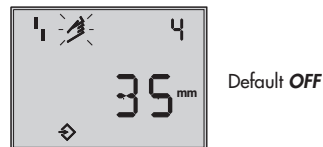

Turn \otimes → Code **4**, press \otimes ,
press \otimes → Select pin position entered during installation, press \otimes .

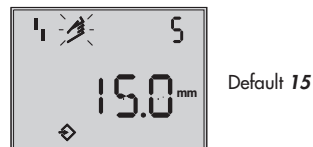

Turn \otimes → Code **5**, press \otimes ,
turn \otimes → Enter nominal travel/angle,
press \otimes .

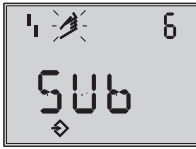

Default **MAX**

Turn ⊗ → Code **6**, press ⊗,
turn ⊗ → **SUB**, press ⊗.

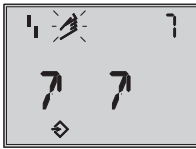

Default ↗↗

Turn ⊗ → Code **7**, press ⊗,
turn ⊗ → Retain direction of action ↗↗ or
select ↘↘.

Press ⊗.



Default **100.0**

Turn ⊗ → Code **11**, press ⊗,
turn ⊗ → Deactivate travel limit,
press ⊗.

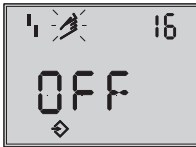

Default **OFF**

Turn ⊗ → Code **16**,
Retain default value for pressure limit,
change value only if necessary.

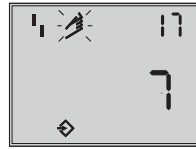

Default **7**

Turn ⊗ → Code **17**

Retain default. Proceed as follows only if
known:

Press ⊗, turn ⊗ → Select Kp,
press ⊗.

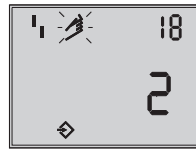

Default **2**

Turn ⊗ → Code **18**,

Retain default Tv, change only if known.



Default **CCL**

Turn ⊗ → Code **34**, press ⊗,
turn ⊗ → Select closing direction.

CCL = counterclockwise and **CL** = clockwise.

Direction of rotation which causes the valve
to move to the **CLOSED** position (view onto
the rotary switch movement while positioner
cover is open).

Press ⊗.

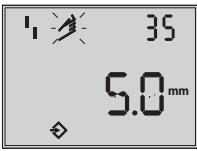

Default **0.0**

- Turn \otimes → Code **35**, press \otimes ,
- turn \otimes → Enter blocking position, e.g. 5 mm (read off at travel indicator scale of the blocked valve or measure with a ruler).
- Press \otimes .

- ▶ Set switch for **fail-safe position** AIR TO OPEN or AIR TO CLOSE as described in section 5.1 on page 42.
- ▶ Set volume restriction as described in section 5.2 on page 43.
- ▶ **Press INIT key!**

The positioner switches to manual operation!

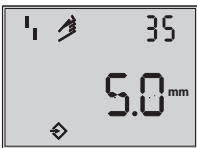

The adjusted blocking position is indicated

As initialization has not been carried out completely, the error code **76** (no emergency mode) and possibly also error code **57** may appear on the display. These indications do not influence the positioner's readiness for operation.

Canceling the blocking position

For the positioner to follow its reference variable again, the blocking position must

be canceled and the positioner must be set to automatic operation **AUTO** as follows:

- Press \otimes → Code **1**, press \otimes ,
- turn \otimes in order to move the valve slightly past the blocking position, then cancel mechanical blocking.
- Press \otimes .
- Turn \otimes → Code **0**, press \otimes ,
- Code **0** blinks.
- Turn \otimes until **AUTO** appears on the display.
- Press \otimes to confirm the operating mode.

The positioner switches to automatic operation!

The current valve position is indicated in %.

Note!

If the positioner shows a tendency to oscillate in automatic operating mode, the parameters K_P and T_V must be slightly corrected. Proceed as follows:

Set T_V to 4 (Code **18**).

If the positioner still oscillates, the gain K_P (Code **17**) must be decreased until the positioner shows a stable behavior.

Zero point correction

Finally, if process operations allow it, the zero point must be adjusted according to section 5.7 on page 54.

Caution!



The positioner automatically moves to zero point.

5.6 Fault/failure

All status and fault alarms are assigned a classified status in the positioner.

To provide a better overview, the classified alarms are summarized in a condensed status for the positioner (see section 6).

The condensed status appears on the display with the following symbols:

Condensed status	Display
Failure	
Maintenance request/ maintenance demand	
Function check	Text
No alarm	

If the positioner has not been initialized, the fault symbol  appears on the display as the positioner cannot follow its reference variable.

Additionally, a signal is issued over the fault alarm contact when certain faults occur (see error code list).

To access the error codes, turn the  button past the Code **50**.

Err appears on the display with the respective error code.

For the cause of the fault and its remedy, refer to the codes listed in section 12 on page 66.

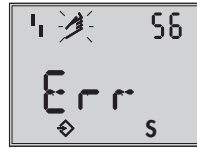

Display indicating an error code

After an error code has occurred, first try to confirm it as follows:

Enable configuration:

Turn  → Code **3**, press .

turn  → **ON**, press .

Turn  until the error code number appears, then press  to confirm it.

Should the error occur again, read the remedy instructions in the error code list.

Occurrences such as when the total valve travel is exceeded or when the temperature leaves the permissible temperature range affect the condensed state and cause a fault alarm to be displayed depending on its classification.

The optional EXPERT+ diagnostics generates additional diagnostic alarms which are included in the condensed status with their corresponding status classification.

When a diagnostic alarm is issued by EXPERT+, this is displayed with Code 79 (see error code list).

5.7 Zero calibration

In case of discrepancies with the closing position of the valve, e.g. with soft-sealed plugs, it may become necessary to recalibrate the zero point.

Enable configuration:

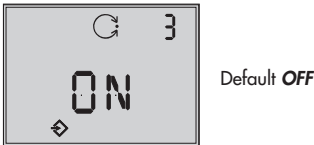

Turn → Code **3**, press ,
turn → **ON**, press .

After enabling:

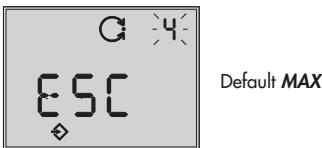

Turn → Code **6**, press ,
turn → **ZP**, press .

► Press INIT key!

Zero calibration is started, the positioner moves the control valve to the CLOSED position and readjusts the internal electrical zero point.



The valve briefly moves from the current travel/angle of rotation position to the closed position.

5.8 Reset to default values

This function resets all parameters to the factory default values (see list of codes in section 12).

Enable configuration:

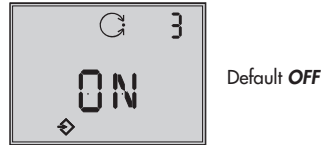

Turn → Code **3**, press ,
turn → **ON**, press .

After enabling:

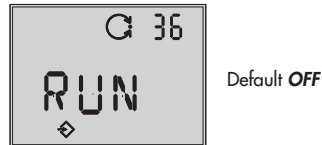

Turn → Code **36**, press ,
turn → **RUN**, press .

All parameters are reset and can be reconfigured.

5.9 Start-up via local interface (SSP)

The positioner must be supplied with at least 4 mA.

The positioner can be connected directly to the PC via the local serial interface and the serial interface adapter.

Use the TROVIS-VIEW software with 3730-2 device module installed. Refer to section 13 for more details.

For start-up and settings, proceed as described in section 5, 5.1 to 5.3 and then proceed as described in section 13.

Note!

Depending on the firmware installed in the positioner, a certain minimum version of the TROVIS-VIEW device module is required for communication.

If you have already installed the software, you can download updates at www.samson.de (Support & Downloads - TROVIS VIEW Updates).

6 Status and diagnostic alarms

The Type 3730-2 Positioner contains an integrated diagnostic approach to generate classified status and diagnostic alarms.

There are two different on-board diagnostics available: the standard integrated diagnostics (EXPERT) and the optional extended EXPERT+ diagnostics.

6.1 Standard EXPERT diagnostics

The standard EXPERT diagnostics provides information about positioner states such as operating hours counter, process monitoring, number of zero calibrations and initializations, total valve travel, temperature, initialization diagnostics, zero/control loop errors, logging of the last 30 alarms, etc.

In addition, the standard EXPERT diagnostics generates diagnostic and status alarms which allow faults to be pinpointed quickly when a fault occurs.

Alarms are classified in the following main groups:

- ▶ Status
- ▶ Operation
- ▶ Hardware
- ▶ Initialization
- ▶ Data memory
- ▶ Temperature

6.2 Extended EXPERT⁺ diagnostics

In addition to the standard EXPERT diagnostic features, the optional EXPERT⁺ extended diagnostics provides the following online and offline test functions which enable significant statements on the condition of the entire control valve.

Online test functions (monitoring functions)

- ▶ Data logger
- ▶ Histogram
- ▶ Cycle counter
- ▶ Valve end position trend
- ▶ $Y = f(X)$ diagram (drive signal)
- ▶ Hysteresis test

Offline test functions (manual functions)

- ▶ $Y = f(X)$ diagram over the entire valve travel range
- ▶ Hysteresis test over the entire valve travel range
- ▶ Static characteristic
- ▶ Step response test

The diagnostic tests are completely integrated in the positioner. Further status alarms are generated from the extensive information gained in the diagnostic tests of EXPERT⁺ which provide the user with information covering the whole control valve.

The required reference curves are automatically plotted after initialization and saved in the positioner if EXPERT⁺ is activated.

The optional diagnostic functions provided by EXPERT⁺ can be selected when ordering

the positioner. Additionally, it is possible to activate EXPERT⁺ at a later point in time in an existing positioner.

For this purpose, an activation code can be ordered, specifying the serial number of the positioner.

6.3 Classification of the status alarms and condensed status

The alarms are assigned a classification status in the positioner. The following states are differentiated between:

Failure

The positioner cannot perform its control task due to a functional fault in the device or in one of its peripherals or an initialization has not yet been successfully completed.

Maintenance demand

The positioner still performs its control task (with restrictions). A maintenance demand or above average wear has been determined. The wear tolerance will soon be exhausted or is reducing at a faster rate than expected. Maintenance is necessary in the medium term.

Maintenance requirement

The positioner still performs its control task (with restrictions). A maintenance demand or above average wear has been determined. The wear tolerance will soon be exhausted or is reducing at a faster rate than expected. Maintenance is necessary in the short term.

Function check

Test or calibration procedures are being performed. The positioner is temporarily unable to perform its control task until this procedure is completed.

Classification process in the positioner

An alarm is assigned to one of following classified states in the table:

Condensed status

To provide a better overview, the state of the positioner is summarized in a condensed status which is made up from a summary of all classified positioner alarms.

If an event is classified as "No alarm", this event does not have any affect on the condensed status of the positioner.

The condensed status is displayed in the engineering tool as well as on the positioner display as in the following table:





Status modification

The classification of the status alarms can be changed as required.

They can be modified using TROVIS-VIEW software over the local SSP interface.

Note!

All additional alarms generated by EXPERT+ have the status "No alarm" by default.

Status alarm	Engineering tool
Alarm inactive	
Alarm active Classified as "No alarm"	
Alarm active Classified as "Maintenance requirement" / "Maintenance demand"	
Alarm active Classified as "Function check"	
Alarm active Classified as "Failure"	







Logging and displaying diagnostic functions/alarms

The last 30 alarms are logged in the positioner. However, it is important to note that the same alarm is only logged once when it first occurs.

The alarms and the condensed states appear on the display as described in the code list (section 12).

In addition, the diagnostic parameters are issued over the communication interface of the positioner.

The diagnostic functions can easily be displayed and configured using the TROVIS-VIEW software connected over the local interface (SSP).

Status alarm	Engineering tool	Positioner display
"Failure"		
"Maintenance requirement" "Maintenance demand"		
"Function check"		Text
"No alarm"		

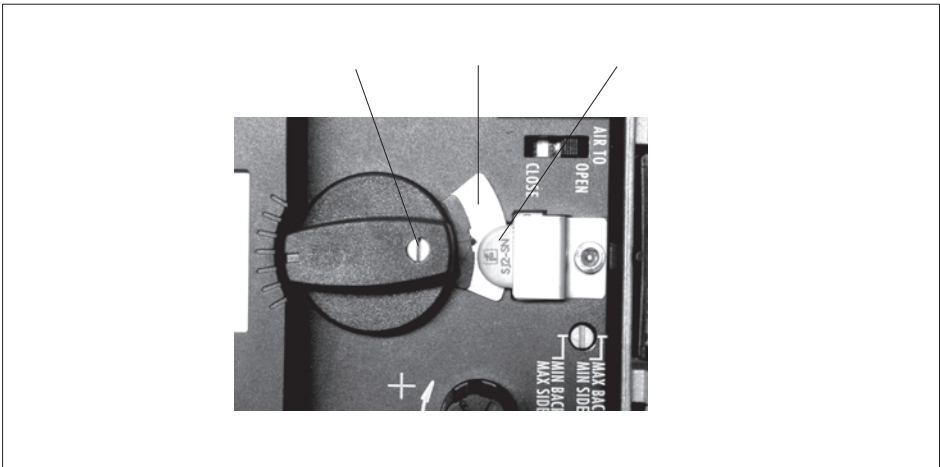

Setting the switching point:

Important!

During adjustment or testing, the switching point must always be approached from mid-position (50 %).

To ensure safe switching under any ambient conditions, the switching point should be adjusted to a value of approx. 5 % before the mechanical stop (OPEN – CLOSED).

For CLOSED position:

1. Initialize positioner.
2. Use the **MAN** function to move the positioner to 5 % (see LC display).
3. Adjust the tag using the yellow adjustment screw (2) until the tag enters or leaves the field and the switching amplifier responds. You can measure the switching voltage as an indicator.

Contact function:

Tag leaving the field > contact is made.

Tag entering the field > contact is opened.

For OPEN position:

1. Initialize positioner.
2. Use the **MAN** function to move the positioner to 95 % (see LC display).
3. Adjust the tag (1) using the yellow adjustment screw (2) until the tag enters or leaves the field of the proximity switch (3).

You can measure the switching voltage as an indicator.

Contact function:

Tag leaving the field > Contact is made.

Tag entering the field > Contact is opened.

8 Quick start-up guide

8.1 Mounting

Direct attachment

to SAMSON Type 3277 Actuator

Travel mm	Actuator cm ²	Pin position
7.5	120	25
15	120/240/350	35
15/30	700	50

Note!

Standard delivery includes lever M ready assembled with the follower pin on 35 mm pin position for 15 mm travel!

To mount the positioner, lift the lever so that the follower pin rests on the follower clamp of the actuator stem.

NAMUR attachment

- ▶ Determine the maximum travel range of the control valve from the closed position to as far it will go in the other direction.
- ▶ Select the lever to match the maximum travel range as well the next largest pin position and screw onto the shaft of the positioner.
- ▶ Lever option/pin distance: see pin position table (Code 4) or cover plate on the positioner.
- ▶ Screw the NAMUR bracket onto the valve yoke so that it is aligned centrally to the slot of the follower plate when the travel position is at 50 %.

- ▶ Secure the positioner to the NAMUR bracket, making sure that the follower pin is in the slot of the follower plate. Make sure the lever can still move.

Attachment to rotary actuators

- ▶ Lever M pin position 90°
- ▶ Put the valve into the closed position, determine the opening direction.
- ▶ Place the follower plate on the slotted actuator shaft and fasten it to the coupling wheel. Attach the top pair of brackets and the bottom pair of brackets to the actuator.
- ▶ Place the positioner on the brackets and screw tight, making sure that the lever with its follower pin engages the slot of the coupling wheel, while taking into account the opening direction. It is important to make sure that the lever's mid position corresponds to the mid travel of the valve (lever's mid position = the lever is parallel to the long side of the positioner casing).

Pneumatic connections

- ▶ Screw the threaded connections only into the attached connection block, connecting plate or pressure gauge block from the accessories.

8.2 Start-up

Connect pneumatic supply air (1.4 to 6 bar).

Apply an electrical reference variable (4 to 20 mA).

Set the fail-safe position

Position the slide switch according to fail-safe position of the control valve:
AIR TO OPEN or AIR TO CLOSE.

Adapt the volume restriction Q to the actuator size

Only set the restriction for actuators < 240 cm² to:
MIN SIDE for connection at the side or
MIN BACK for connection at the back.

Note!

After each change of the volume restriction setting, the positioner must be re-initialized.

Changing the reading direction of the display

(if necessary)

Turn  → Code 2, press ,

turn  → Display ok, press .

Operation

Selecting the parameters or values

Each parameter has a code number which is shown in the display. Use the  button to select.

Turn the button to select parameters or values and then **push** to confirm.

Select and confirm **ESC** to prevent an entered value from being accepted.

Enabling parameters

Parameters that have a code marked with an asterisk (*) can only be changed when they are enabled beforehand using Code 3.

The configuration mode is shown in the display with the  symbol.

See list of codes from page 66 onwards or cover plate of the positioner for a description of the menu codes.

8.3 Initialization

Important!

Perform a reset (Code **36**) prior to each initialization

Turn  → Code **3**, ↓

turn  → ON, ↓

turn  → Code **36**, ↓

select **RUN**, ↓

Caution!

During initialization, the valve runs through its whole range of travel/angle of rotation.

8.3.1 Simplest method (MAX)

Mount and start up the positioner and press the **INIT** key!

READY!

The positioner adapts itself automatically to the maximum travel/angle of rotation range of the control valve.

8.3.2 Precise method (NOM)

Positioner adapts itself precisely to the nominal travel/rotational angle of the control valve!

Mount and start up the positioner, then proceed as follows:

Turn  → Code **3**, ↓

turn  → ON, ↓

turn  → Code **4**, ↓

Select pin position, ↓

turn  → Code **5**, ↓

Enter nominal travel/range, ↓

turn  → Code **6**, ↓

select **NOM**, ↓

Press **INIT** key!

8.3.3 Manual method (MAN)

Initialization mode same as **NOM**, but for start-up of control valves with unknown nominal ranges. The final position of travel/angle of rotation (valve open) is entered manually.

Mount and start up the positioner, then proceed as follows:

Turn  → Code **0**, ↓,

turn  → select **MAN**, ↓

turn  → Code **1**, ↓,

turn  → valve **open** position, ↓



turn  → Code **3**, ↓,

turn  → **ON**, ↓

turn  → Code **6**, ↓, select **MAN**, ↓

Press **INIT** key!

Note!

After imposing the electrical reference variable, the positioner is in the last used operating mode. Code **0** appears in the display. If the positioner has not yet been initialized, the fault  symbol appears on the display and the  symbol blinks.

9 Retrofitting an inductive limit switch

Required retrofit kit:

Limit switch Order no. 1400-7460

1. Take off the rotary pushbutton (3) and cap (1), unthread the five fixing screws (2) and lift off the plastic cover (9).
2. Use a knife to cut an opening at the marked location (4).
3. Push the connector (11) with cable through the opening and secure the proximity switch (7) on the cover with a dot of glue.
4. Remove the jumper at the socket ST1 of the top board and insert the cable connector (11).
5. Guide the cable in such a manner that the plastic cover can be placed back onto the positioner. Insert the fixing screws (2) and screw tight. Attach the clamping plate (8) onto the proximity switch.
6. Attach the rotary switch (5). Make sure the flattened side of the positioner shaft is turned so that the rotary switch (5) can be attached with the metal tag next to the proximity switch.
7. **Important!**
On start-up of the positioner, set the option "inductive alarm" under Code **38** from **NO** to **YES**.

- | | |
|---------------------|--------------------|
| 1 Cap | 6 Metal tag |
| 2 Screws | 7 Proximity switch |
| 3 Rotary pushbutton | 8 Clamping plate |
| 4 Marking | 9 Plastic cover |
| 5 Rotary switch | 11 Connector |

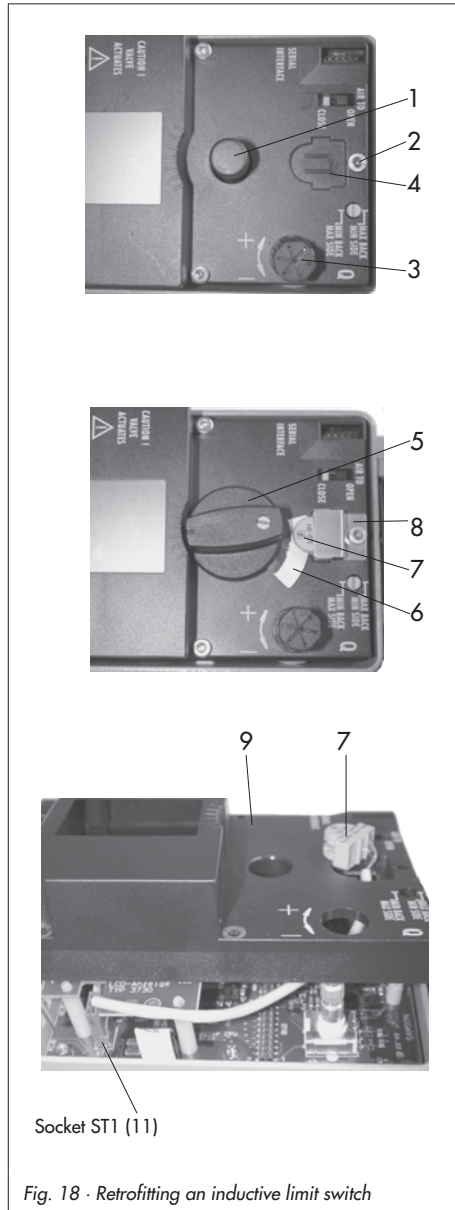

Fig. 18 · Retrofitting an inductive limit switch

10 Maintenance

The positioner does not require any maintenance.

There are filters with a 100 µm mesh size in the pneumatic connections for supply and output which can be removed and cleaned, if required.

The maintenance instructions of any upstream supply air pressure reducing stations must be observed.

11 Servicing explosion-protected devices

If a part of the positioner on which the explosion protection is based needs to be serviced, the positioner must not be put back into operation until an expert has inspected the device according to explosion protection requirements, has issued a certificate stating this or given the device a mark of conformity.

Inspection by an expert is not required if the manufacturer performs a routine check on the device prior to putting it back into operation. The passing of the routine check must be documented by attaching a mark of conformity to the device.

Explosion-protected components may only be replaced by original, checked components from the manufacturer.

Devices that have already been used outside of hazardous areas and are intended for use in hazardous areas in future must comply with the safety demands placed on repaired devices. Prior to operation, they must be tested according to the specifications stipulated for "Repairing explosion-protected devices".

12 Code list

Code no.	Parameter – Display, values [default setting]	Description																											
Important! Codes with marked with an asterisk (*) must be enabled with Code 3 prior to configuration.																													
0	Operating mode [MAN] AuTO SAFE ESC	AuTO = Automatic mode MAN = Manual mode SAFE = Fail-safe position ESC = Escape Switchover from automatic to manual mode is smooth. In fail-safe mode, the symbol S appears on the display. In MAN and AuTO mode, the system deviation is represented by the bar graph elements. When the positioner is initialized, the numerical display indicates the valve position or the angle of rotation in %, otherwise the position of the sensor in relation to the central axis is displayed in degrees °.																											
1	Manual w 0 to 100 [0] % of the nominal range	Adjust the manual set point with the rotary pushbutton, the current travel/angle is displayed in % when the positioner is initialized, otherwise the sensor position in relation to the central axis is indicated in degrees °.																											
2	Reading direction Normal or upside down ESC	The reading direction of the display is turned by 180°.																											
3	Enable configuration [OFF] ON ESC	Activates the option to modify data (automatically deactivated when the rotary pushbutton has not been operated for 120 s.)																											
4*	Pin position [OFF] 17, 25, 35, 50 mm 70, 100, 200 mm, 90° with rotary actuators ESC Note! If you select a pin position in Code 4 that is too small, the positioner switches to SAFE mode for reasons of safety	For initialization using NOM or SUB, the follower pin must be inserted into the correct pin position according to the valve travel/angle of rotation. <table border="1"> <thead> <tr> <th>Pin position Code 4</th> <th>Standard Code 5</th> <th>Adjustment range Code 5</th> </tr> </thead> <tbody> <tr> <td>17</td> <td>7.5</td> <td>3.6 to 17.7</td> </tr> <tr> <td>25</td> <td>7.5</td> <td>5.0 to 25.0</td> </tr> <tr> <td>35</td> <td>15.0</td> <td>7.0 to 35.4</td> </tr> <tr> <td>50</td> <td>30.0</td> <td>10.0 to 50.0</td> </tr> <tr> <td>70</td> <td>40.0</td> <td>14.0 to 70.7</td> </tr> <tr> <td>100</td> <td>60.0</td> <td>20.0 to 100.0</td> </tr> <tr> <td>200</td> <td>120.0</td> <td>40.0 to 200.0</td> </tr> <tr> <td>90°</td> <td>90.0</td> <td>24.0 to 110.0</td> </tr> </tbody> </table>	Pin position Code 4	Standard Code 5	Adjustment range Code 5	17	7.5	3.6 to 17.7	25	7.5	5.0 to 25.0	35	15.0	7.0 to 35.4	50	30.0	10.0 to 50.0	70	40.0	14.0 to 70.7	100	60.0	20.0 to 100.0	200	120.0	40.0 to 200.0	90°	90.0	24.0 to 110.0
Pin position Code 4	Standard Code 5	Adjustment range Code 5																											
17	7.5	3.6 to 17.7																											
25	7.5	5.0 to 25.0																											
35	15.0	7.0 to 35.4																											
50	30.0	10.0 to 50.0																											
70	40.0	14.0 to 70.7																											
100	60.0	20.0 to 100.0																											
200	120.0	40.0 to 200.0																											
90°	90.0	24.0 to 110.0																											

5*	Nominal range [15.0] mm or angle ° ESC	For initialization using NOM or SUB, the nominal travel/angle of rotation of the valve must be entered. The permissible adjustment range depends on the pin position according to the table for Code 4. After initialization has been successfully completed, the maximum nominal travel/angle reached on initialization is displayed.
6*	Init mode [MAX] NOM MAN SUB ZP ESC	Select the initialization mode MAX: Maximum range of the control valve, the travel/angle of the closure member from the CLOSED position to the opposite stop in the actuator. NOM: Nominal range of the control valve, the travel/angle of the closure member measured from the CLOSED position to the indicated OPEN position. MAN: Manual adjustment: upper x-range value SUB: No self-adjustment (emergency mode) ZP: Zero calibration
7*	w/x [↗↗] ↗↘ ESC	Direction of action of the reference variable w in relation to the travel/angle of rotation x (increasing/increasing or increasing/decreasing) Automatic adaptation: AIR TO OPEN: On completion of initialization, the direction of action remains increasing/increasing (↗↗), a globe valve opens as the mA signal increases. AIR TO CLOSE: On completion of initialization, the direction of action changes to increasing/decreasing (↗↘), a globe valve closes as the mA signal increases.
8*	Lower x-range value 0.0 to 80.0 [0.0] % of the nominal range, Specified in mm or angle ° provided Code 4 is set ESC	Lower range value for the travel/angle of rotation in the nominal or operating range. The operating range is the actual travel/angle of the control valve and is limited by the lower x-range value (Code 8) and the upper x-range value (Code 9). Usually, the operating range and the nominal range are identical. The nominal range can be limited to the operating range by the lower and upper x-range values. Value is displayed or must be entered. The characteristic is adapted. See also the example in Code 9!

9*	Upper x-range value 20.0 to 100.0 [100.0] % nominal range, Specified in mm or angle ° provided Code 4 is set ESC	Upper range travel/angle of rotation in the nominal or operating range. Value is displayed or must be entered. The characteristic is adapted. Example: The operating range is modified, for example, to limit the range of a control valve which has been sized too large. For this function, the entire resolution range of the reference variable is converted to the new limits. 0 % on the display corresponds to the set lower limit and 100 % to the set upper limit.
10*	Lower x-limit [OFF] 0.0 to 49.9 % of the operating range ESC	Limitation of the travel/angle of rotation downwards to the entered value, the characteristic is not adapted. The characteristic is not adapted to the reduced range. See also example in Code 11.
11*	Upper x-limit [100 %] 50.0 to 120.0 [100] % of the operating range or OFF ESC	Limitation of the travel/angle of rotation upwards to the entered value, the characteristic is not adapted. Example: In some applications, it makes sense to limit the valve travel, e.g. if a certain minimum medium flow is required or a maximum flow must not be reached. The lower limit must be adjusted with Code 10, and the upper limit with Code 11. If a tight-closing function has been set up, it has priority over the travel limitation! When set to OFF, the valve can be opened past the nominal travel with a reference variable outside of the 4 to 20 mA range.
12*	w-start 0.0 to 75.0 [0.0] % of the reference variable range ESC	Lower range value of the applicable reference variable range must be smaller than the final value w-end, 0 % = 4 mA The reference variable range is the difference between w-end and w-start, and must be $\Delta w \geq 25 \% = 4 \text{ mA}$. For an adjusted reference variable range of 0 to 100 % = 4 to 20 mA, the control valve must move through its entire operating range from 0 to 100 % travel/angle of rotation. In split-range operation , the valves operate with smaller reference variables. The control signal of the control unit to control two valves is divided such, for instance, that the valves move through their full travel/angle of rotation at only half the input signal (first valve set to 0 to 50 % = 4 to 12 mA and second valve set to 50 to 100 % = 12 to 20 mA reference variable).
13*	w-end 25.0 to 100.0 [100.0] % of the reference variable range ESC	Upper range value of the applicable reference variable range, must be greater than w-start. 100 % = 20 mA

14*	Final position w < 0.0 to [1.0] % of the span adjusted via Code 12/13 OFF ESC	If w approaches up to 1 % towards the final value that causes the valve to close, the actuator is immediately completely vented (with AIR TO OPEN) or filled with air (with AIR TO CLOSE). This action always lead to maximum tight-closing of the valve. Codes 14/15 have priority over Codes 8/9/10/11.
15*	Final position w > [OFF] 50.0 to 100.0 % of the span adjusted via Code 12/13 ESC	If w approaches up to 99 % towards the final value that causes the valve to open, the actuator is immediately completely filled with air (with AIR TO OPEN) or vented (with AIR TO CLOSE). This action always lead to the valve being completely opened. Codes 14/15 have priority over Codes 8/9/10/11. Example: Set the final position w > to 99 % for three-way valves.
16*	Pressure limit [OFF] 1.4 2.4 3.7 bar ESC	The signal pressure can adopt the value of the applied supply pressure at the maximum [OFF] or it can be limited in stages of 1.4, 2.4 or 3.7 bar. This pressure limitation is already effective during the initialization. Note: After changing a pressure limit already set, the actuator must be vented once (e.g. by selecting the fail-safe position over Code 0).
17*	KP step 0 to 17 [7] ESC	Displaying or changing K_p Note on changing the K_p and T_V steps: During the initialization of the positioner, the K_p and T_V values are optimized. Should the positioner show a tendency for impermissibly high post-pulse oscillation due to additional interference, the K_p and T_V steps can be adapted after the initialization. For this, either the T_V step can be increased in increments until the desired response behavior is reached or, when the maximum value of 4 is reached, the K_p step can be decreased in increments. CAUTION! Changing the K_p step influences the system deviation. This effect decreases as the K_p step increases.
18*	TV step [2] 1 2 3 4 OFF ESC	Displaying or changing T_V , See note under K_p step A change of the T_V step has no effect on the system deviation.

19*	Tolerance band 0.1 to 10.0 [5] % of the operating range ESC	Used for error monitoring Determination of the tolerance band in relation to the operating range. Associated lag time [30] s is a reset criterion. If, during initialization, a transit time is determined which is 6 times > 30 s, the 6fold transit time is accepted as lag time.
20*	Characteristic 0 to 9 [0] ESC	Select the characteristic: 0: Linear 1: Equal percentage 2: Reverse equal percentage 3: Butterfly valve linear 4: Butterfly valve eq. percentage 5: Rotary plug valve linear 6: Rotary plug valve eq. perc. 7: Segmented ball valve linear 8: Segmented ball valve eq. p. 9: User-defined * * Definition over SAMSON TROVIS-VIEW software
21*	w-ramp Open 0 to 240 s [0] ESC	The time required to pass through the operating range when the valve opens. Limitation of the transit time (Code 21 and 22): For some applications it is recommendable to limit the transit time of the actuator to prevent it from engaging too fast in the running process.
22*	w-ramp Closed 0 to 240 s [0] ESC	The time required to pass through the operating range when the valve closes.
23*	Total valve travel 0 to 9999 [0] subsequently 10E3-99E7 RES ESC	Totalled double valve travel. Can be reset to 0 via RES.
24*	LV total valve travel 1000 to 9999 [100 000] subsequently 10E3-99E7ESC	Limit value of total valve travel. If the limit value is exceeded, the fault symbol and the wrench symbol appear. Exponential display for 10 000 travel cycles onwards.

25*	Alarm mode 0 to 3 [2] ESC	Switching mode of software limit switches alarm A1 and A2 in responding state (when positioner initialized). 1) Explosion-protected version according to EN 60947-5-6 0: A1 ≥ 2.1 mA A2 ≤ 1.2 mA 1: A1 ≤ 1.2 mA A2 ≤ 1.2 mA 2: A1 ≥ 2.1 mA A2 ≥ 2.1 mA 3: A1 ≤ 1.2 mA A2 ≥ 2.1 mA 2) Version without explosion protection 0: A1 R = 348 Ω A2 Non-conducting 1: A1 Non-conducting A2 Non-conducting 2: A1 R = 348 Ω A2 R = 348 Ω 3: A1 Non-conducting A2 R = 348 Ω When a positioner has not been initialized, the software limit switches always register the signal as in the state of no response. If there is no mA signal at the terminals 11/12, the software limit switches both switch to ≤ 1.2 mA signal (Ex) or non-conducting (without explosion protection).
26*	Limit value A1 OFF 0.0 to 100.0 [2.0] % of the operating range ESC	Displaying or changing the software limit value A1 in relation to the operating range. Setting has no effect when an inductive limit switch has been installed.
27*	Limit value A2 OFF 0.0 to 100.0 [98.0] % of the operating range ESC	Displaying or changing the software limit value A2 in relation to the operating range.
28*	Alarm Test Reading direction: Standard Turned [OFF] [OFF] RUN 1 1 RUN RUN 2 2 RUN RUN 3 3 RUN ESC ESC	Testing the software limit switches alarm A1 and A2 in addition to the fault alarm contact A3. If the test is activated, the respective limit switches five times. RUN1/1 RUN: Software limit switch A1 RUN2/2 RUN: Software limit switch A2 RUN3/3 RUN: Fault alarm contact A3

29*	Position transmitter x/ix ³⁾ [↗]↘ ↘ ESC	<p>Operating direction of the position transmitter; indicates how the travel/angle position is assigned to the output signal i, based on the closed position.</p> <p>The operating range (see Code 8) of the valve is represented by the 4 to 20 mA signal. Values exceeding or falling below the limits 2.4 to 21.6 mA can be represented.</p> <p>When a positioner has not been initialized (reference variable less than 3.6 mA), the power consumption of the feedback signal is effective (current approx. 1.8 mA).</p> <p>When YES is set in Code 32, the position transmitter issues the value as per Code 30 during initialization or zero calibration.</p> <p>When NO is set in Code 32, 4 mA is issued during a running self-adaptation.</p>
30*	Fault alarm ix ³⁾ [OFF] HI LO ESC	<p>Used to select whether faults causing the fault alarm contact to switch should also be signaled through the position transmitter output and how they should be signaled</p> <p>HI ix > 21.6 mA or LO ix < 2.4 mA</p>
31*	Position transmitter test ³⁾ -10.0 to 110.0 [x before the function is triggered] % of the operating range ESC	<p>Testing the position transmitter. Values can be entered in relation to the operating range.</p> <p>The current actual value is used in initialized positioners locally as the start value (bumpless changeover to the test mode). On testing over software, the entered simulation value is issued as the position feedback signal for 30 seconds.</p>
³⁾ Analog position transmitter: Code 29/30/31 can only be selected if the position transmitter (optional) is installed.		
32*	Display special functions NO [YES] ESC	<p>Fault alarm via display and fault alarm contact for special functions, e.g. zero calibration, initialization and position transmitter test (Code 31).</p>
33*	Display total valve travel NO [YES] ESC	<p>Fault alarm via display and fault alarm contact when the limit value for the total valve travel is exceeded.</p>
34*	Closing direction CL [CCL] ESC	<p>CL: Clockwise, CCL: Counterclockwise</p> <p>Turning direction in which the valve is moved to the Closed position (view onto the rotary switch motion when the positioner cover is open).</p> <p>Needs only be entered in initialization mode SUB (Code 6).</p>
35*	Blocking position [0] mm/° /% ESC	<p>Entering the blocking position.</p> <p>Distance up to the Closed position.</p> <p>Only necessary in initialization mode SUB.</p>

36*	Reset [OFF] RUN ESC	Resets all parameters to default (factory setting). Note: After setting RUN , the positioner must be re-initialized.
37	Position transmitter Yes No	Display only, indicates whether the position transmitter option is installed.
38*	Inductive alarm [NO] YES ESC	Indicates whether the inductive limit switch option is installed or not.
39	System deviation e info -99.9 to 999.9 % ,	Display only, indicates the deviation from the set point position.
40	Transit time Open info 0 to 240 s [0]	Display only, minimum opening time is determined during initialization
41	Transit time Closed info 0 to 240 s [0]	Display only, minimum closing time is determined during initialization
42	Auto-w info 0.0 to 100.0 % of the span 4 to 20 mA	Display only, indicates the supplied automatic reference variable corresponding 4 to 20 mA.
43	Firmware info Xxxx	Display only, indicates the current firmware version of the positioner.
44	y info [0] OP 0 to 100 % MAX	Display only, blocked prior to initialization. After initialization: indicates the actuator pressure in %. 0 to 100 % corresponds to the pressure range which adjusts the travel/angle range from 0 to 100 %. If the actuator pressure is 0 bar, e.g. due to tight-closing on bottom or fail-safe action, 0 P appears on the display. If the actuator pressure is higher than the pressure required for X = 100 %, e.g. due to tight-closing on top, MAX appears on the display. Value is determined during initialization.
45	Solenoid valve info Yes No	Display only, indicates whether a solenoid valve is installed.

48	Diagnostics	
	d	Diagnostic parameters
	d0 Current temperature -55 to 125	Operating temperature [°C] inside the positioner
	d1 Minimum temperature [20]	The lowest temperature below 20 °C that has ever occurred.
	d2 Maximum temperature [20]	The highest temperature above 20 °C that has ever occurred.
	d3 Number of zero calibrations	The number of zero calibrations since the last initialization.
	d4 Number of initializations	The number of initializations that have been performed.
	d5 Zero point limit [5 %] 0.0 to 100.0 %	Limit for the zero point monitoring.
	d6 Condensed status	Condensed status, made up from the individual states. OK: Okay, C: Maintenance requirement, CR: Maintenance demand, B: Failure, I: Function check.
	d7 Start reference run [OFF] ON ESC 1	Triggering of a reference run for the functions: Drive signal Y stationary and drive signal Y hysteresis. The reference run can only be activated in manual operation as the valve moves through its entire travel range. If EXPERT ⁺ is activated at later point in time, the reference graphs must be plotted in order to activate the diagnostic functions.
d8 EXPERT ⁺ activation	Enter the activation code for EXPERT ⁺ . After the activation procedure has been successfully completed, YES appears under d8.	

Error codes – Remedy		Condensed status alarm active, when prompted, Err appears.
Initialization error (indicated on the display by the condensed status with the corresponding classification)		
50	$x < \text{range}$	<p>The value supplied by the measuring signal is either too high or too low, the measuring sensor is close to its mechanical limit.</p> <ul style="list-style-type: none"> • Pin positioned incorrectly. • Bracket slipped in case of NAMUR attachment or positioner is not central. • Follower plate incorrectly attached.
	Remedy	Check attachment and pin position, set operating mode from SAFE to MAN and re-initialize the positioner.
51	$\Delta x > \text{range}$	<p>The measuring span of the sensor is too low.</p> <ul style="list-style-type: none"> • Pin positioned incorrectly. • Wrong lever. <p>A rotational angle smaller than 11° at the positioner shaft creates just an alarm. An angle below 6° leads to the initialization being canceled.</p>
	Remedy	Check attachment and re-initialize the positioner.
52	Attachment	<ul style="list-style-type: none"> • Positioner attachment incorrect. • Nominal travel/angle (Code 5) could not be achieved on initialization under NOM or SUB (no tolerance downwards permissible) • Mechanical or pneumatic error, e.g. wrong lever selected or supply pressure too low to move to the required position or pneumatic fault
	Remedy	<p>Check attachment and supply pressure. Re-initialize the positioner.</p> <p>Under certain circumstances, it may be possible to check the maximum travel/angle by entering the actual pin position and then performing an initialization under MAX.</p> <p>After initialization has been completed, the Code 5 indicates the maximum achieved travel or angle.</p>
53	Init time >	<p>The initialization routine lasts too long. The positioner returns to its previous operating mode.</p> <ul style="list-style-type: none"> • No pressure on the supply line or there is a leak. • Supply air failure during initialization.
	Remedy	Check attachment and supply pressure. Re-initialize the positioner.

54	Init – Solenoid valve	<p>1) A solenoid valve is installed (Code 45 = YES) and was not or not properly connected so that an actuator pressure could not be built up. The message appears when you attempt to initialize the positioner.</p> <p>2) If you attempt to initialize the device from the fail-safe position (SAFE).</p>
	Remedy	<p>Re. 1) Check connection and supply voltage of the solenoid valve.</p> <p>Re. 2) Set the MAN operating mode over Code 0. Then initialize the positioner.</p>
55	Transit time <	The actuator transit times determined during the initialization are so short that the positioner cannot adapt itself optimally.
	Remedy	Check the volume restriction setting as described in section 5.2, re-initialize the positioner.
56	Pin pos.	Initialization was canceled because you are required to enter the pin position for the selected initialization modes NOM and Sub .
	Remedy	Enter pin position over Code 4 and nominal travel/angle over Code 5. Re-initialize the positioner.
Operational error (indicated on the display by the condensed status with the corresponding classification)		
57	Control loop	Control loop fault, the control valve does not react within the tolerable times of the controlled variable (tolerance band alarm Code 19).
	Additional message at the fault alarm contact!	<ul style="list-style-type: none"> • Actuator mechanically blocked. • Attachment of the positioner subsequently postponed. • Supply pressure not sufficient.
	Remedy	Check attachment.
58	Zero point	Zero point incorrect. Error may arise when the mounting position/linkage of the positioner moves or when the valve seat trim is worn, especially with soft-sealed plugs.
	Remedy	Check valve and mounting of the positioner. If OK, perform a zero calibration over Code 6 (see section 5.7 on page 54).
59	Autocorrection	Should an error occur in the data range of the positioner, the self-monitoring function recognizes it and automatically corrects it.
	Remedy	Automatic

60	Fatal error	An error was detected in the data relevant for safety, autocorrection is not possible. This may be due to EMC disturbances. The control valve is moved to the fail-safe position.
	Additional message at the fault alarm contact!	Remedy Reset over Code 36. Re-initialize the positioner.
Hardware error (indicated on the display by the condensed status with the corresponding classification)		
62	x signal	Determination of the measured value for the actuator has failed. Conductive plastic element is defective. The positioner continues to run in emergency mode, but should be replaced as soon as possible. The emergency mode on the display is indicated by a blinking control symbol and 4 dashes instead of the position indication. Note on the control: If the measuring system has failed, the positioner is still in a reliable state. The positioner switches to emergency mode where the position cannot be accurately controlled anymore. However, the positioner continues operation according to its reference variable signal so that the process remains in a safe state.
	Additional message at the fault alarm contact!	Remedy Return the positioner to SAMSON AG for repair.
63	w too small	The reference variable is much smaller than 4 mA (0 %); occurs if the power source that drives the positioner does not comply with the standard. This state is indicated on the positioner display by a blinking LOW .
		Remedy Check reference variable. If necessary, limit the current source downwards so that no values below 4 mA can be issued.
64	i/p converter (y)	The circuit of the i/p converter has been interrupted.
		Remedy Cannot be remedied. Return the positioner to SAMSON AG for repair.

Error appendix		
65	Hardware Additional message at the fault alarm contact!	A hardware error has occurred, the positioner moves to the fail-safe position SAFE .
	Remedy	Confirm error and return to the automatic operating mode, or perform a reset and re-initialize the device. If this is not successful, return device to SAMSON AG for repair.
66	Data memory Additional message at the fault alarm contact!	The writing of data to the data memory does not work anymore, e.g. when the written data deviate from the read data. Valve moves to the fail-safe position.
	Remedy	Return the positioner to SAMSON AG for repair.
67	Test calculation Additional message at the fault alarm contact!	The hardware positioner is monitored by means of a test calculation.
	Remedy	Confirm error. If this is not possible, return the positioner to SAMSON AG for repair.
Data error		
68	Control parameter Additional message at the fault alarm contact!	Control parameter error, e.g. due to EMC disturbances.
	Remedy	Confirm error, perform reset and re-initialize the positioner.
69	Poti parameter Additional message at the fault alarm contact!	Parameter error of the digital potentiometer.
	Remedy	Confirm error, perform reset and re-initialize the positioner.
70	Calibration Additional message at the fault alarm contact!	Error in the production calibration data, e.g. due to EMC disturbances. Subsequently, the device runs on default values
	Remedy	Return the positioner to SAMSON AG for repair.
71	General parameters	Parameter errors that are not critical for the control.
	Remedy	Confirm error. Check and, if necessary, reset required parameters.
72	Start-up parameters	Start-up parameter errors
	Remedy	Confirm error, perform reset and re-initialize the positioner.

73	Internal device error 1	Internal device error
	Remedy	Return the positioner to SAMSON AG for repair.
75	Parameter info	Error in the parameter info which is not critical for the control.
	Remedy	Confirm error. Check and, if necessary, reset required parameters.
76	No emergency mode	The travel measuring system of the positioner has a self-monitoring function (see Code 62). A controlled emergency mode is not available on certain actuators, such as double-acting actuators. For this reason, the positioner moves into the fail-safe position when a measuring error occurs. During the initialization, the positioner checks whether the actuator has such a function or not.
	Remedy	Merely information, confirm, if necessary. No further action necessary.
77	Program loading error Additional message at the fault alarm contact!	When the device starts operation for the first time after the input signal has been applied, it carries out a self-test (#EStinG runs across the display). If the device loads a program that does not correspond to that of the positioner, the valve is moved into the fail-safe position. It is not possible to make the valve leave this fail-safe position again by operating the positioner.
	Remedy	Interrupt current supply and restart positioner. Otherwise, return the positioner to SAMSON AG for repair.
78	Options parameter	Errors in options parameters, e.g. due to EMC disturbances.
	Remedy	Return the positioner to SAMSON AG for repair.
79	Diagnostic alarms	Alarms are generated in the EXPERT ⁺ extended diagnostics if EXPERT ⁺ has been successfully activated in Code 48.
80	Diagnostic parameters	Error which is not critical for control.
	Remedy	Confirm error. Check and, if necessary, start new reference run.
81	Reference graphs	Error on plotting the reference graphs of drive signal Y stationary or drive signal Y hysteresis. <ul style="list-style-type: none"> • Reference run was interrupted • Reference line Y stationary or Y hysteresis was not adopted.

13 Setting with TROVIS-VIEW software – Parameter list

13.1 General

A CD-ROM containing the program for installing the TROVIS-VIEW Configuration and Operator Interface is provided by SAMSON.

Insert the installation CD-ROM to start the installation program. Once inserted, the CD-ROM usually starts the installation program automatically depending on the configuration of the operating system.

If the program does not start automatically, double-click **setup.exe** in the root directory of the CD-ROM in order to install TROVIS-VIEW.

Follow the on-screen prompts and instructions of the installation program.

The system requirements are specified in the **readme.txt** file in the root directory of the CD-ROM.

The TROVIS-VIEW Operator Interface can be used for different SAMSON devices. Note that the installation program also offers you the option of installing a demo module. To use the software without restrictions, the software needs to be activated as described below:

After installation, a dialog box will appear, prompting you to enter the CD key, which you will find on the cover of the original CD-ROM. Once you have entered the correct CD key and initiated the activation process, a request code will be automatically generated. The *Activation* dialog box will come up displaying the generated request code and an Internet link to SAMSON's activation server where a unique activation code will then be generated and displayed. Enter this activation code into TROVIS-VIEW's *Activation* dialog box. The software is now ready for use without any restrictions in the purchased scope.

To enable communication with the PC, connect the serial interface to the serial interface (5-pole female socket) of the positioner using a SAMSON connecting cable with serial interface adapter (order no. 1400-7700).

The positioner settings configured in TROVIS-VIEW can be directly transferred over the SAMSON connecting cable to the positioner on site. This online connection enables you to read any entered settings as well as providing a diagnostic function.

13.2 Starting TROVIS-VIEW and performing basic settings

Settings may be entered into the TROVIS-VIEW operator interface when either the positioner is connected or not connected. When the positioner is connected, the data uploaded from the positioner can be overwritten.

When the positioner is not connected, the default settings appear on the operator interface display or, alternatively, a stored TROVIS-VIEW file (*.tro) can be loaded and written over in the *File* menu by selecting *Open*.

Connection to the positioner is established by clicking the symbols on top right on the button bar:



Upload data from the positioner and displayed in the operator interface



Download data onto the positioner from the operator interface



The positioner is in online mode, indicated by the TROVIS-VIEW 3 logo on the top right in the blue bar



The positioner is in offline mode.

You can also activate the listed functions in the *Device* menu.

1. Start TROVIS-VIEW

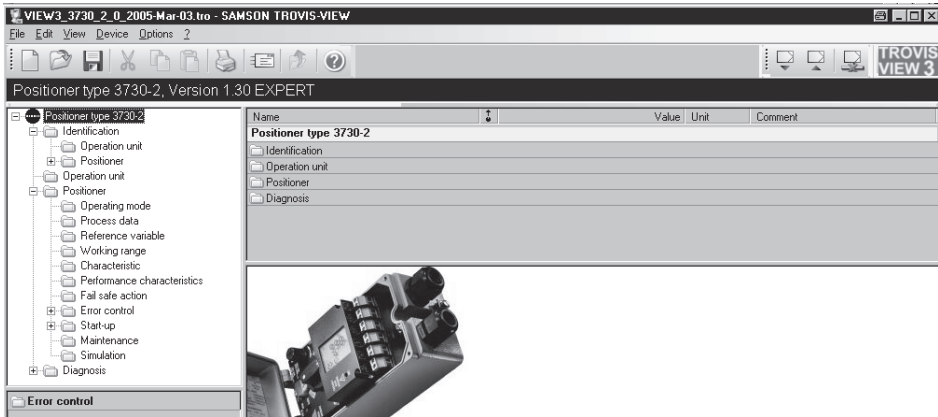

Make required settings in *View* menu by activating or deactivating functions.

When the Trend Viewer is activated, all operating data are uploaded cyclically from the positioner in online mode and shown in the form of graphs.

Right-click on the graph to edit the graph format or to copy the logged data to a file.

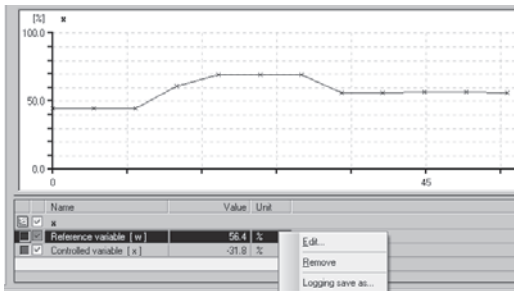

2. Select required language in *Options* menu.

The selected language can be changed at any time except in online mode.

3. Select *Communication* from the *Options* menu and choose communication settings.

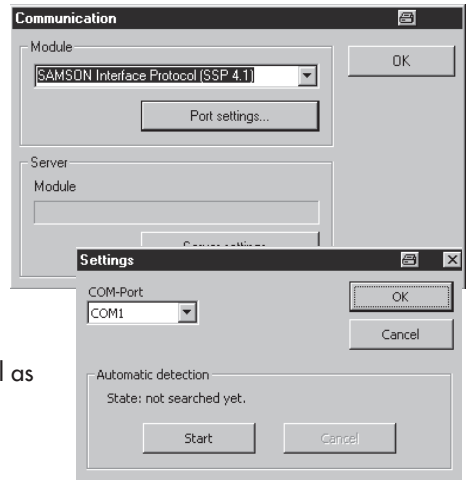

4. Click on *Port settings* and select port as well as server setting.

5. Select *Convert* in the *File* menu to select the firmware version of the positioner. It must match the version specified in the bar at the top.

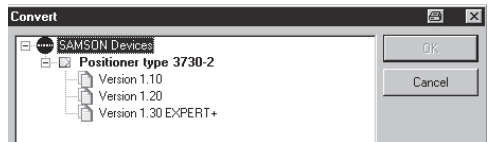

6. Enter more details about the plant, if necessary, in *Customer Data* in the *Edit* menu.

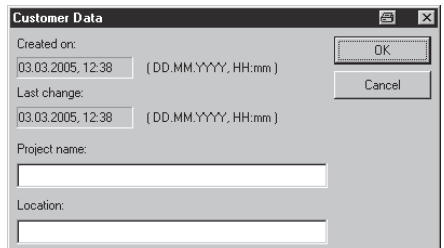

7. Select *Load Factory Defaults* in *Edit* menu to upload default settings to the operator interface.

13.3 Setting the parameters

Click on one of the folders listed in the left column to open a window listing the settings of the corresponding parameters. Place the mouse arrow on the parameter name to open a tool tip providing information about that particular parameter.

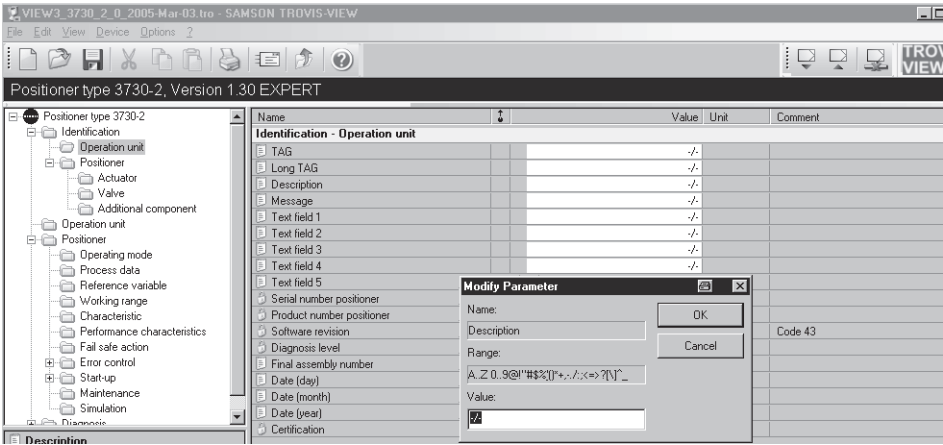

Double-click on a parameter to open a window to enable the parameter to be modified.

Right-click on the parameter to open a drop-down menu providing further editing options.

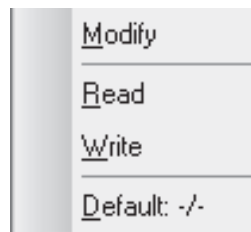

The parameters in all the folders are listed in the following parameter list.







13.4 Parameter list

Parameter	Values	Default setting	Description Refer to section 12 for the description of the codes
Identification – Operation unit			
TAG	Max. 32 characters		Tag identification of operation unit
Long TAG			
Bus address		0	Code 46
Description			Freely available text fields
Message			
Text field 1 to 5			
Positioner serial number			Serial number of the positioner
Positioner product number		3730-3 xxx	Manufacturer model number of the positioner
Firmware version		x.xx	Current firmware version of device, Code 43
Diagnosis level		EXPERT	
Final assembly number	0...16777215	0	Any number assignable to clearly identify the entire field device
Date (day)	1...31	1	Date that can be entered. Stored in the positioner
Date (month)		January	
Date (year)	1900...2155	2003	
Certification			Indicates whether the positioner can be used in hazardous area
Identification – Positioner			
Device type		3730-2	Indicates exact model designation

Setting with TROVIS-VIEW software – Parameter list

Identification – Positioner – Actuator			
Type identification actuator			Manufacturer ID number of the actuator that the positioner is mounted upon
Actuator type	Single-acting Double-acting	Single-acting	Actuator with or without spring return mechanism
Attachment	Integral/ NAMUR	Integral	Defines the attachment of the positioner on the control valve
Booster	Not present/ present	Not present	Pneumatic volume booster
Actuator size	60...5600	240 cm ²	Effective diaphragm or piston area of the actuator
Signal pressure lower value	0.0...6	0.2 bar	Initial value of the actuator bench range
Signal pressure upper value	0.0...6	1.0 bar	Final value of the actuator bench range
Supply pressure	0.0...6	6.0 bar	Supply pressure of compressed air network
Identification – Positioner – Valve			
Type identification valve			Manufacturer ID number of the valve that the positioner is mounted upon
Direction of flow	Flow-to-open (FTO)/ Flow-to-close (FTC)	Flow-to-open (FTO)	Indicates in which direction the process medium flows to the valve plug.
Packing	Adjustable/ Self-adjusting/ Bellows seal	Self-adjusting	Sealing of the plug stem to the atmosphere
Seating surface (leakage class)	Metal sealing/ Lapped-in metal/ Soft sealing/ Nickel sealing	Metal sealing	Type of sealing between seat and plug
Pressure balancing	Without/ With (PTFE)/ With (Graphite)	Without	Plug with pressure balancing to compensate for forces
Flow characteristic	Linear 30:1/ Eq. perc. 30:1/ Linear 50:1/ Eq. perc. 50:1/ Other	Linear 50:1	Valve characteristic: Flow to valve travel

Parameter	Values	Default	Description
Valve dimensions standard	DIN/ANSI	DIN	Valve dimensions according to DIN or ANSI
Nominal size DN	8...2100	50	Nominal size in mm (DIN) or inch (ANSI)
Kvs coefficient	0.0001... 20000.0000	1.0000 Kv	Valve flow coefficient
Kvs unit	Kv/cv	Kv	Flow coefficient, metric unit (Kvs) or US American units (cv)
Seat diameter of the valve	2.0...500.0	6.0 mm	Diameter of valve seat bore
Identification – Positioner – Additional components			
Solenoid valve		Not installed	Code 45
Position transmitter			Code 37
Inductive limit switch	Installed/ Not installed		Code 38
Operation unit			
Start with default settings			Code 36
Positioner – Operating mode			
Current operating mode			Indicated the current operating mode used by the device
Target operating mode	Automatic/ Manual/Fail-safe position	Automatic	Code 0
Positioner – Process data			
Reference variable w	Displays current process variables		Code 42
Controlled variable x			Current position

Status		
Condensed state		<p>Summarized state of the positioner. The condensed status is made up from the various states. The condensed status can take on the following states:</p> <p>No alarm </p> <p>Maintenance requirement </p> <p>Maintenance demand </p> <p>Failure </p> <p>Function check </p> <p>The condensed states "Maintenance requirement" and "Maintenance demand" are also indicated on the positioner display by . The condensed status "Failure" causes the  fault alarm symbol to appear on the display.</p>
Fault exists (fault alarm contact)	Display and alarm	Status of the fault alarm contact
Status of limit switch A1		Status of the switching output for limit switch A1
x falls below A1		Indicates whether the controlled variable x has fallen below the limit for A1
Status of limit switch A2		Status of the switching output for limit switch A2
x exceeds A2		Indicates whether the controlled variable x has exceeded the limit for A2
Operational status		Indicates the current operational status of the internal control
Temperature		Current temperature in the positioner

Parameter	Value	Default	Description
Positioner – Reference variable			
Direction of action	Increasing/ increasing >> Incr./decr. <<	Increasing/ increasing >>	Code 7
Lower reference range value	0.0...75.0 %	0.0 %	Code 12
Upper reference range value	25.0...100.0 %	100.0 %	Code 13
Enable final position smaller than w	On/Off	On	Code 14
Final position when w is smaller	0.0...49.9 %	1.0 %	Code 14
Enable final position greater than w	On/Off	Off	Code 15
Final position when w is greater	50.0...100.0 %	100.0 %	Code 15
Required transit time OPEN	0...240 s	0 s	Code 21
Required transit time CLOSED	0...240 s	0 s	Code 22
Positioner – Working range			
Initial value of travel range/angle of rotation range	0.0...12.0 mm	0.0 %	Code 8
Final value of travel range/angle of rotation range	3.0...15.0 mm	100.0 %	Code 9
Enable travel/angle of rotation lower limit	On/Off	Off	Code 10
Travel/angle of rotation lower limit	0.0...49.9 %	0.0 %	Code 10
Enable travel/angle of rotation upper limit	On/Off	On	Code 11
Travel/angle of rotation upper limit	50.0...120.0 %	100.0 %	Code 11

Positioner – Characteristic			
Characteristic selection	Linear Equal percentage Eq. perc. reverse SAMSON butterfly valves linear eq. perc. VETEC rotary plug valves linear eq. perc. Segmented ball valves linear eq. perc. User defined	Linear	Code 20 Graphs of the user-defined characteristics, loading and saving characteristics. See example on the next page.
Characteristic type			Free text for describing the user-defined characteristic

Example for user-defined characteristic

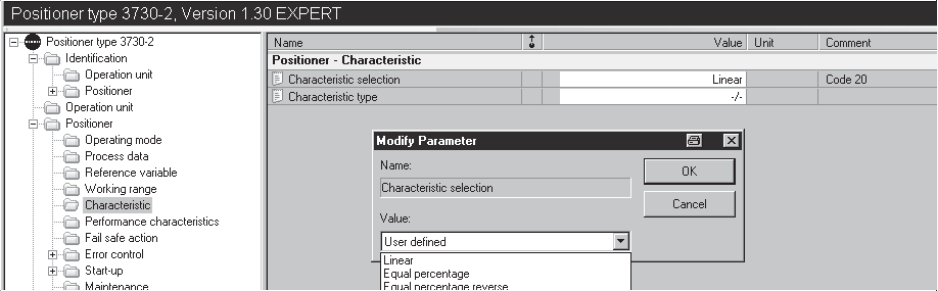

- Select **User defined characteristic** in *Characteristic selection* parameter.
- Double-click on **Edit, open or save characteristic** to open a window where the characteristic can be edited.

Click on *Characteristic* button on the bottom right to open and save a characteristic.

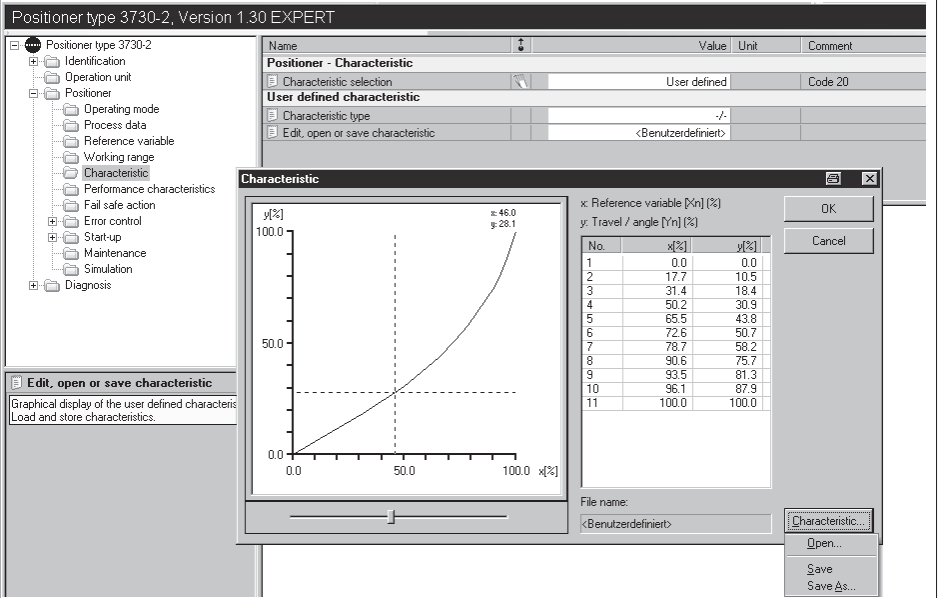

Setting with TROVIS-VIEW software – Parameter list

Parameter	Values	Default	Description
Positioner – Performance characteristics			
Required proportional-action coefficient KP (step)	0...17	7	Code 17
Proportional-action coefficient KP (step)			Code 17
Required derivative-action time TV (step)	Off/1/2/3/4	2	Code 18
Derivative-action time TV (step)			Code 18
Positioner – Fail-safe action			
Fail-safe position		Closing	Fail-safe action of the actuator upon air/auxiliary power failure or device start-up. Determined during initialization by the position of the slide switch (see section 5.1). In double-acting actuators, the fail-safe position relates only to the failure of the auxiliary power supply. There is no defined position when the supply air fails.
Positioner – Error control			
Tolerance band	0.1...10.0 %	5.0 %	Code 19
Delay time	0...9999 s	30 s	Reset criterion for running control loop monitoring. A control loop error is issued when the delay time is exceeded and the system deviation is not within the tolerance band.
Total valve travel		1	Code 23
Limit of the total valve travel	1000... 990 000 000	1 000 000	Code 24
Alarm mode	A1 Conducting/high A2 Non-conduc./low A1 Non-conduc./low A2 Non-conduc./low A1 Conducting/high A2 Conduc./high A1 Non-conduc./low A2 Conducting/high	A1 Conducting/ high A2 Conducting/ high	Code 25

Enable limit value A1	On/Off	On	Code 26
Limit value A1	0.0...100.0 %	2.0 %	Code 26
Enable limit value A2	On/Off	On	Code 27
Limit value A2	0.0...100.0 %	98.0 %	Code 27
Fault alarm special functions	Yes/No	Yes	Code 32
Fault alarm total valve travel	Yes/No	Yes	Code 32
Zero point limit	0.0...100.0 %	5.0 %	Limit for zero point monitoring







Positioner – Error control – Classification report

Condensed status error alarms

Note!

Each error alarm has a status assigned to it.





The possible states are placed in order starting with the lowest priority:

Maintenance demand		Lowest
Maintenance requirement		
Failure		
Function check		
No alarm		Alarm is not added to the condensed status

The fault alarm present in the device with the highest priority determines which condensed status is displayed.

The condensed states "Maintenance requirement" and "Maintenance demand" are also indicated on the positioner display by .

The condensed status "Failure" causes the  fault alarm symbol to appear on the display.

x > range	Determines the individual status for each alarm	Code 50	
Delta x < range		Code 51	
Attachment		Code 52	
Initialization time exceeded		Code 53	
Initialization/ solenoid valve		Code 54	
Transit time not achieved		with symbol 	Code 55
Pin position		an alarm is not added to the condensed status	Code 56
Control loop			Code 57
Zero point			Code 58
Autocorrection			Code 59
x signal		Code 62	
w too small		Code 63	
Control parameter	Symbol 	Code 68	
Poti parameter	for maintenance requirement and maintenance demand	Code 69	
Calibration parameter		Code 70	
General parameters		Code 71	
Internal device error 1	Symbol 	Code 73	
Parameter info	for failure	Code 75	
No emergency mode		Code 76	
Options parameter		Code 78	
Total valve travel exceeded		Determines the condensed status when a fault occurs	
Temperature < -40 °C	or symbol 	Temperature fell below -40 °C during operation	
Temperature > 80 °C	for function check	Temperature exceeded +80 °C during operation	

Positioner – Start-up			
Reading direction	Pneumatic connection right/left	Pneumatic connection right	Code 2
Pin position	Off 17/25/35/50/ 70/100/200 mm 90°	Off	Code 4
Initialization mode	Nominal range Maximum range Manual adjustment Substitution	Maximum range	Code 6
Pressure limit	Off /2.4 /3.7 / 1.4 bar	Off	Code 16
Determined nominal range			Code 5
Minimum transit time OPEN			Code 40
Minimum transit time CLOSED			Code 41
Fail-safe action			Fail-safe action of the actuator upon air/auxiliary power failure or device start-up. Determined during initialization by the position of the slide switch (see section 5.1). In double-acting actuators, the fail-safe position relates only to the failure of the auxiliary power supply. There is no defined position when the supply air fails.

Setting with TROVIS-VIEW software – Parameter list

Positioner – Start-up – Initialization			
Initialization mode	Nominal range Maximum range Manual adjustment Substitution	Maximum range	Code 6
Device initialized			Status of device initialization
Initialization			Starting of initialization procedure. The initialization mode parameter must be first set to the required initialization procedure.
Initialization status			Status of the running initialization procedure
Initialization canceled			Running initialization procedure has been canceled. The control valve moves to its fail-safe position.
Target operating mode	Automatic Manual SAFE	Automatic	Code 0
Current operating mode			Indicates current operating mode of positioner
Initialization error			
x > range	Alarm		Code 50
Delta x < range			Code 51
Attachment			Code 52
Initialization time exceeded			Code 53
Initialization/sole-noid valve			Code 54
Transit time too short			Code 55
Pin position			Code 56
No emergency mode			Code 76
Positioner – Start-up – Substitution			
Initialized in Sub mode			Indicates whether the substitute configuration (sub mode) has been performed
Closing direction		Counter-clockwise	Code 34
Blocking position		0.0 %	Code 35

Positioner – Maintenance			
Start zero calibration			
Zero calibration			Starts zero calibration
Initialization status			Status of running initialization procedure
Initialization canceled			Running initialization procedure has been canceled. The control valve moves to fail-safe position.
Target operating mode	Automatic Manual SAFE	Automatic	Code 0
Current operating mode			Indicates current operating mode of positioner
Parameter folder	Values	Default	Description
Positioner – Simulation			
Alarm test A1			Code 28
Alarm test A2			Code 28
Alarm test A3 (alarm fault output)			Code 28
Diagnosis			
Diagnosis level setting		Expert	
Current operating mode		Automatic	Indicates current operating mode of positioner

Diagnosis – Status alarms		
Status		
Condensed status	Alarm symbol	Summarized condensed status. Made up from various states.
Operating hours counter	Display or status	Time elapsed since first initialization
Device in closed loop		Time elapsed in closed loop since first initialization
Device switched on since last initialization		Time elapsed since last initialization
Device in closed loop since last initialization		Time elapsed in closed loop since last initialization
Error occurred (fault alarm output)		Status of fault alarm output
Solenoid valve status		Status of optional solenoid valve
Fail-safe position		Fail-safe action of actuator upon air supply/auxiliary power failure or device start-up. Determined during initialization.
Device initialized		Status of device initialization
Start performed with default settings		Indicates whether a start has been performed with default settings.
Local operation active		Local operation is active
Configuration changed		Status of device status bit configuration changed.
Number of zero calibrations		Number of zero calibrations performed since last initialization
Number of initializations		Number of initializations performed
Zero point limit	Limit for zero point monitoring	

Operation		
Control loop	Alarm	Code 57
Zero point		Code 58
Autocorrection		Code 59
Fatal error		Code 60
w too small		Code 63
Total valve travel exceeded		Status of total valve travel limit
Temperature exceeded		Status alarm resulting from diagnosis analysis
Hardware		
x-signal	Alarm	Code 62
i/p converter		Code 64
Hardware		Code 65
Data memory		Code 66
Control calculation		Code 67
Program load error		Code 77
Initialization		
x range	Alarm	Code 50
Delta x < range		Code 51
Attachment		Code 52
Initialization time exceeded		Code 53
Initialization/ solenoid valve		Code 54
Transit time too short		Code 55
Pin position		Code 56
No emergency mode		Code 76

Setting with TROVIS-VIEW software – Parameter list

Data memory		
Control parameter	Alarm	Code 68
Poti parameter		Code 69
Calibration parameter		Code 70
General parameters		Code 71
Internal device error 1		Code 73
Info parameter		Code 75
Option parameter		Code 78
Diagnostic parameters		Code 80
Temperature		
Min. temperature	Display	Lowest temperature recorded in the positioner
Max. temperature		Highest temperature recorded in the positioner
Min. temperature (time)		Operating hours counter logging when the lowest temperature was recorded in the positioner
Max. temperature (time)		Operating hours counter logging when the highest temperature was recorded in the positioner
Diagnosis – Status messages – Data logger		
Alarms (1) to (30)	Alarm	Recorded alarms issued by the positioner
Operating hours since first initialization		Operating hours counter logging of each alarm

Diagnosis – Status alarms – Reset		
Reset absolute total travel	Resetting corresponding alarms	Reset counter for absolute total valve travel back to 0
Reset default values flag		Set back default values flag to 0
Reset configuration changed		Reset device status bit configuration changed.
Reset initialization error		
Reset x > range	Resetting corresponding alarms	Code 50
Reset Delta x < range		Code 51
Reset attachment		Code 52
Reset initialization exceeded		Code 53
Reset initialization/sole-noid valve		Code 54
Reset transit time too short		Code 55
Reset pin position		Code 56
Reset operational error		
Reset zero point	Resetting corresponding alarms	Code 58
Reset autocorrection		Code 59
Reset hardware error		
Reset hardware	Resetting corresponding alarms	Code 65
Reset control calculation		Code 67

Reset data error		
Reset control parameter	Resetting corresponding alarms	Code 68
Reset poti parameter		Code 69
Reset general parameters		Code 71
Reset options parameter		Code 78
Reset diagnostic parameters		Code 80
Reset statistical information		
Reset data logger		Measured data in the data logger buffer memory are deleted

14 Dimensions in mm

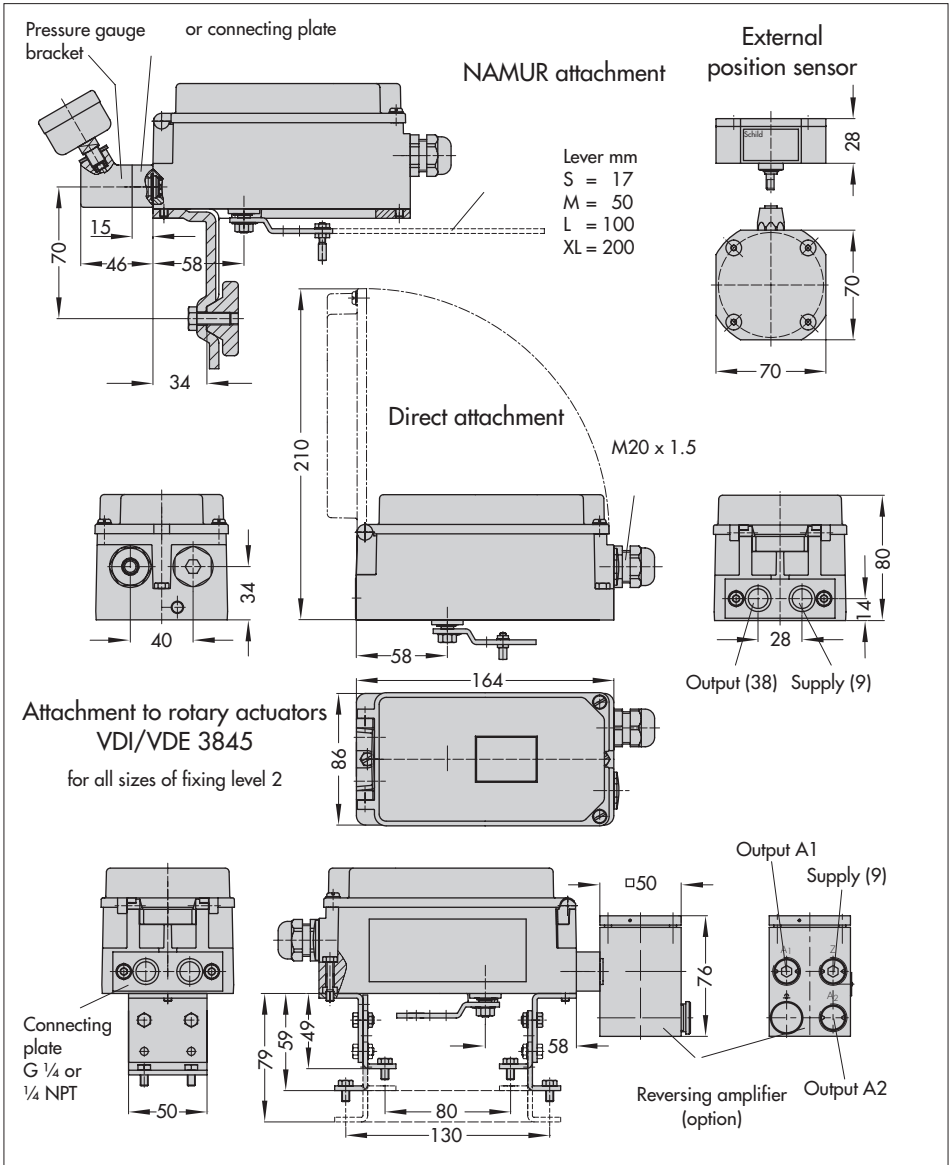

 <h1 style="text-align: center;">IECEX Certificate of Conformity</h1>	
<h2 style="text-align: center;">INTERNATIONAL ELECTROTECHNICAL COMMISSION</h2> <h3 style="text-align: center;">IEC Certification Scheme for Explosive Atmospheres</h3> <p style="text-align: center; font-size: small;">for rules and details of the IECEx Scheme visit www.iecex.com</p>	
Certificate No.: IECEX PTB 05/007 Status: Current Date of Issue: 2005-02-21 Applicant: SAMSON AG Mess- und Regeltechnik Weismuellerstrasse 3 D-60314 Frankfurt am Main Germany	Issue No.: 0 Page 1 of 3
Electrical Apparatus: op-positioner type 3750-21.. General accessory	
Type of Protection: General Requirements, Intrinsic Safety, Protection by Enclosure	
Marking: Ex ia IIC T6T5T4 IP 54 and IP 65 T 80 °C	
Approval for Issue on behalf of the IECEx Certification Body: Dr.-Ing. Ulrich Johannsmeyer Department Head Intrinsic Safety and Safety of Systems	
Signature: _____ (for approval vector)	
Date: _____	
1. This certificate and schedule may only be reproduced in full. 2. This certificate is not transferable and remains the property of the issuing body. 3. The Status and authenticity of this certificate may be verified by visiting the Official IECEx Website.	
Certificate issued by: Physikalisch-Technische Bundesanstalt (PTB) Bundesallee 100 38116 Braunschweig Germany	

 <h1 style="text-align: center;">IECEX Certificate of Conformity</h1>	
Certificate No.: IECEX PTB 05/007 Date of Issue: 2005-02-21 Manufacturer: SAMSON AG Mess- und Regeltechnik Weismuellerstrasse 3 D-60314 Frankfurt am Main Germany	
Manufacturing location(s):	
This certificate is issued as verification that a sample(s), representative of production, was assessed and tested and found to comply with the IEC Standard list below and that the manufacturer quality system, relating to the Ex products covered by this certificate, is in accordance with the IECEx Scheme Rules, IECEx 02 and Operational Documents as amended.	
STANDARDS: The electrical apparatus and any acceptable variations to it specified in the schedule of this certificate and the identified documents, was found to comply with the following standards.	
IEC 60079-0 : 2000 Edition: 3.1 IEC 60079-11 : 1999 Edition: 4 IEC 61241-1-1 : 1999 Edition: 2	Electrical apparatus for explosive gas atmospheres - Part 0: General requirements Electrical apparatus for explosive gas atmospheres - Part 11: Intrinsic safety 'y' Electrical apparatus for use in the presence of combustible dust - Part 1-1: Electrical apparatus protected by enclosures and surface temperature limitation - Specification for apparatus
This Certificate does not include compliance with <i>intrinsic safety and performance requirements other than those expressly stated in the Standards listed above.</i>	
TEST & ASSESSMENT REPORTS: A sample(s) of the equipment listed has successfully met the <i>verification and test requirements as recorded in</i>	
IECEx ATR: DE/PTB05-004 File Reference: BC02158	



IECEx Certificate of Conformity

Certificate No.: IECEx PTB 05.0007

Date of Issue: 2015-02-21

Issue No.: 0

Page 3 of 3

Schedule

EQUIPMENT:

Equipment and systems covered by this certificate are as follows:

General description: single or double-acting pistons for attachment to pneumatic actuators with self-balancing automatic adjustment to valve and actuator. Reference variable: 4 to 20mA. Nominal travels 3.6 to 200 mm; angles of rotation: 24 to 100° Features: Simple attachment to current linear and rotary actuators with interface for SAMSON - direct attachment, NAMUR-fit, attachment to rod-type yoke act, to IEC 60534-6-1. Any mounting position. Options: Position indicator, proximity switch, force limiting function, fail alarm output, external displacement transducer and serial interface.

CONDITIONS OF CERTIFICATION: NO



TRANSLATION

EC TYPE EXAMINATION CERTIFICATION

- (1) Equipment and Protective Systems Intended for Use in Potentially-Explosive Atmospheres – **Directive 94/9/EC**
- (2) EC Type Examination Certificate Number
PTB 00 ATEX 2158
- (3) Equipment: Model 3730-21... /IP Positioner
- (4) Manufacturer: SAMSON AG
- (5) Address: Weismüllerstr. 3, D-60314 Frankfurt, Germany
- (6) This equipment and any acceptable variation thereof are specified in the schedule to this certificate.
- (7) The Physikalisch-Technische Bundesanstalt, certified body number 0102 in accordance with Article 9 of the Council Directive 94/9/EC of 23 March 1994, certifies that this equipment has been found to comply with the Essential Health and Safety Requirements relating to the design and construction of equipment and protective systems intended for use in potentially explosive atmospheres given in Annex II to the Directive.

The examination and test results are recorded in confidential report
PTB Ex 01-2021.6.

- (8) The Essential Health and Safety Requirements are satisfied by compliance with
EN 50014: 1997 **EN 50020: 1994**
- (9) If the sign "CE" is placed after the certificate number, it indicates that the equipment is subject to special conditions for safe use specified in the schedule to this certificate.

EC Type Examination Certificates without signature and seal are invalid.
This EC Type Examination Certificate may only be reproduced in its entirety and without any changes, schedule included.
Errors or changes shall require the prior approval of the Physikalisch-Technische Bundesanstalt.

Physikalisch-Technische Bundesanstalt, Bundesallee 100, D-38116 Braunschweig
PTB18-3730.dnc

Test Report: **PTB Ex 01-2021.6**

- (10) According to the Directive 94/9/EC, this EC TYPE EXAMINATION CERTIFICATE relates only to the design and construction of the specified equipment. If applicable, further requirements of this Directive apply to the manufacture and supply of the equipment.

- (11) The marking of the equipment shall include the following:



Zertifizierungsstelle Explosionsschutz
By order Braunschweig, 01 March 2001

(Signature) (Seal)

Dr. Ing. U. Jahnsmeyer
Regierungsdirktor

EC Type Examination Certificates without signature and seal are invalid.
This EC Type Examination Certificate may only be reproduced in its entirety and without any changes, schedule included.
Errors or changes shall require the prior approval of the Physikalisch-Technische Bundesanstalt.

Physikalisch-Technische Bundesanstalt, Bundesallee 100, D-38116 Braunschweig
PTB18-3730.dnc

(13) **S c h e d u l e**(14) **EC TYPE EXAMINATION CERTIFICATE No. PTB 99 ATEX 2158**(15) **Description of Equipment**

The Model 3730-21... /i/p Positioner is a single- or double-acting positioner for attachment to linear or rotary actuators. It serves for translating control signals into valve stem positions.

The Model 3730-21... /i/p Positioner is a passive two-terminal network which may be connected to any certified intrinsically safe circuit, provided the permissible maximum values of U_i , I_i and P_i are not exceeded.

For pneumatic auxiliary power non-combustible media are used.

The device is intended for use inside and outside of hazardous areas.

The correlation between temperature classification and permissible ambient temperature ranges are shown in the table below:

Temperature class	Permissible ambient temperature range
T6	-40 °C ... 60 °C
T5	-40 °C ... 70 °C
T4	-40 °C ... 80 °C

Version 3730-211... with inductive limit switch (terminals 41/42)

The correlation between temperature classification, permissible ambient temperature ranges and maximum short-circuit current for analysers is shown in the table below:

Temperature class	Permissible ambient temperature range	Maximum short-circuit current
T6	-40 °C ... 45 °C	
T5	-40 °C ... 60 °C	52mA
T4	-40 °C ... 75 °C	
T6	-40 °C ... 60 °C	
T5	-40 °C ... 80 °C	25mA
T4	-40 °C ... 80 °C	

This EC Type Examination Certificate may only be reproduced in its entirety and without any changes, schedule included. Details or changes shall require the prior approval of the Physikalisch-Technische Bundesanstalt.

Physikalisch-Technische Bundesanstalt, Bundesallee 100, D-38116 Braunschweig **PTB18-3730-08c**

Electrical data

Signal circuit
(terminals 11/12)

Type of protection: Intrinsic safety EEx ia IIC
only for connection to a certified intrinsically safe circuit

Maximum values:

U_i = 28 V
 I_i = 115 mA
 P_i = 1 W

C_i = 5.3 nF, L_i = negligible

Version 3730-21...1.
Position indicator
(terminals 31/32)

Type of protection: Intrinsic safety EEx ia IIC
only for connection to a certified intrinsically safe circuit

Maximum values:

U_i = 28 V
 I_i = 115 mA
 P_i = 1 W

C_i = 5.3 nF, L_i = negligible

Version 3730-211...
software limit switches
(terminals 41/42, 51/52)

Type of protection: Intrinsic safety EEx ia IIC
only for connection to a certified intrinsically safe circuit

Maximum values:

U_i = 28 V
 I_i = 115 mA
 P_i = 1 W

C_i = 5.3 nF, L_i = negligible

Inductive limit switch
(terminals 41/42)

Type of protection: Intrinsic safety EEx ia IIC
only for connection to a certified intrinsically safe circuit

Maximum values:

U_i = 16 V
 I_i = 52 mA
 P_i = 169 mW

C_i = 60 nF, L_i = 200 μ H, or

This EC Type Examination Certificate may only be reproduced in its entirety and without any changes, schedule included. Details or changes shall require the prior approval of the Physikalisch-Technische Bundesanstalt.

Physikalisch-Technische Bundesanstalt, Bundesallee 100, D-38116 Braunschweig **PTB18-3730-08c**

Physikalisch-Technische Bundesanstalt
 Braunschweig und Berlin

U _i	=	16	V
I _i	=	23	mA
P _i	=	64	mW
C _i	=	60	nF, L _i = 200
			μH

Forced venting function
(terminals 81/82)

Type of protection: Intrinsic safety EEx to IIC
only for connection to a certified intrinsically safe circuit

Maximum values:

U	=	28	V
I _i	=	115	mA
P _i	=	0.5	W
C _i	=	5.3	nF, L _i = negligible

Alarm output
(terminals 83/84)

Type of protection: Intrinsic safety EEx to IIC
only for connection to a certified intrinsically safe circuit

Maximum values:

U	=	20	V
I _i	=	60	mA
P _i	=	250	mW
C _i	=	5.3	nF, L _i = negligible

Programming jack BU

Type of protection: Intrinsic safety EEx to IIC

Maximum values:

U ₀	=	6.51	V
I ₀	=	37.5	mA
P ₀	=	94	mW, Linear characteristic
C ₀	=	22	μF, L ₀ = 10
			mH

only for connection to a certified
intrinsically safe circuit

EC Type Examination Certificates without signature and seal are invalid.
This EC Type Examination Certificate may only be reproduced in its entirety and without any changes, schedule included.
Extracts or changes shall require the prior approval of the Physikalisch-Technische Bundesanstalt.

Physikalisch-Technische Bundesanstalt, Bundesallee 100, D-38116 Braunschweig
 PflBtB-3730.d0c

Physikalisch-Technische Bundesanstalt
 Braunschweig und Berlin

Maximum values:

U _i	=	20	V
I _i	=	60	mA
P _i	=	250	mW

C_i = negligible, L_i = negligible

The rules for interconnecting intrinsically safe circuits shall be complied with.

External position sensor
(analog pcb, pins, p9², p10, p11)

Type of protection: Intrinsic safety EEx to IIC

Maximum values:

U ₀	=	6.51	V
I ₀	=	6	mA
P ₀	=	91	mW, Linear characteristic
C ₀	=	11.2	μF, L ₀ = 11.6
			mH
C _i	=	730	nF, L _i = 370
			μH

(16) Test Report: **PTB Ex 01-20216**

(17) **Special conditions for safe use**

Not applicable

(18) **Special Health and Safety Requirements**

In compliance with the standards specified above

Zertifizierungsstelle Explosionsschutz
By order Braunschweig, 1 March 2001

(Signature) (seal)

Dr.-Ing. U. Johannsmeyer
Regierungsdirektor

EC Type Examination Certificates without signature and seal are invalid.
This EC Type Examination Certificate may only be reproduced in its entirety and without any changes, schedule included.
Extracts or changes shall require the prior approval of the Physikalisch-Technische Bundesanstalt.

Physikalisch-Technische Bundesanstalt, Bundesallee 100, D-38116 Braunschweig
 PflBtB-3730.d0c

TRANSLATION
ADDENDUM No. 1

In compliance with Directive 94/9/EC Annex III Clause 6
to the EC Type Examination Certificate PTB 00 ATEX 2156

Equipment: e/p Positioner Model 3730-21...

Marking:  II 2 G Ex ia IIC T6

Manufacturer: SAMSON AG

Address: Weismüllerstr. 3, D-60314 Frankfurt, Germany

Description of the additions and modifications

The e/p Positioner Model 3730-21... is permitted to be manufactured in compliance with the documents listed below.

The Modifications related to the internal and external structure. The chokes DR1 and DR2 in the position indicator circuit are replaced by the transformer T8 for EMC reasons.

The electrical data and all other data apply unchanged also to this Addendum No. 1

Test report: PTB Ex 02-22028

Zertifizierungsstelle Explosionschutz Braunschweig, 01. March 2002

By order

(Signature)

(Seal)

Dr. Ing. U. Johannsmeyer
Regierungsdirktor

EC Type Examination Certificates without signature and seal are invalid.
This EC Type Examination Certificate may only be reproduced in its entirety and without any changes, scribbles included.
Extracts or changes shall require the prior approval of the Physikalisch-Technische Bundesanstalt.

Physikalisch-Technische Bundesanstalt, Bundesallee 100, D-38116 Braunschweig

PTB16add1.doc



The electrical data and all the other information contained in the EC Type Examination Certificate apply unchanged also to this Addendum No. 2.

ADDENDUM No. 2

in compliance with Directive 94/9/EC Annex III Clause 6
to the EC Type Examination Certificate PTB 00 ATEX 2158

PTB Ex 04-23429

Braunschweig, 16 February 2004

Test report:

Zertifizierungsstelle Explosionsschutz

By order

Equipment: Model 3730-21...e/p Positioner

Marking: II 2G EEx ia IIC T6

Manufacturer: SAMSON AG

Address: Weismüllerstr. 3, D-60314 Frankfurt, Germany

(Signature) (Seal)

Dr. Ing. U. Gerlach

Description of the additions and modifications

The Model 3730-21...e/p Positioner is permitted to be manufactured also in compliance with the test documents specified in the attached test report PTB Ex 04-23429.

Attachment to pneumatic control valves or butterfly valves is either directly to the Series 3277 Actuators or by means of NAMUR adapter plate to actuators of conventional design.

The modifications relate to the internal and external design.

- The circuitry of the supply pcb and the multifunction pcb replace the previous analog pcb, and the position indicator module has been modified.
- The Model 3730-21...e/p Positioner satisfies the requirements of EN 50281-1-1:1998 relating to electrical apparatus with protection provided by the enclosure. According to this standard, the positioner shall be provided in addition with the following marking: II 2D IP65 T80 °C

EC Type Examination Certificate without signature and seal are invalid.

This EC Type Examination Certificate may only be reproduced in its entirety and without any changes, schedule included. Errors or changes shall require the prior approval of the Physikalisch-Technische Bundesanstalt.

Physikalisch-technische Bundesanstalt, Bundesallee 100, D-38116 Braunschweig

PTB18Ad4r1.doc

EC Type Examination Certificate without signature and seal are invalid.

This EC Type Examination Certificate may only be reproduced in its entirety and without any changes, schedule included. Errors or changes shall require the prior approval of the Physikalisch-Technische Bundesanstalt.

Physikalisch-technische Bundesanstalt, Bundesallee 100, D-38116 Braunschweig

PTB18Ad4r1.doc

TRANSLATION Statement of Conformity

- (1) Equipment and Protective Systems Intended for Use in Potentially Explosive Atmospheres – **Directive 94/9/EC**
- (2) EC Type Examination Certificate Number
PTB 03 ATEX 2016 X
- (3) Equipment: Model 3730-2B... e/p Positioner
- (4) Manufacturer: SAMSON AG
- (5) Address: Weismüllerstr. 3, D-60314 Frankfurt, Germany
- (6) This equipment and any acceptable variation thereof are specified in the schedule to this certificate.
- (7) The Physikalisch-Technische Bundesanstalt, notified body number 0102 according to Article 9 of the Council Directive 94/9/EC of 23 March 1994, certifies that this equipment has been found to comply with the Essential Health and Safety Requirements relating to the design and construction of equipment and protective systems intended for use in potentially explosive atmospheres as specified in Annex II to the Directive.
- (8) The examination and test results are recorded in confidential report
PTB Ex.03-22404.
- (9) The Essential Health and Safety Requirements are satisfied by compliance with **EN 50021: 1999**
- (10) If the sign "X" is placed after the certificate number, it indicates that the equipment is subject to special conditions for safe use specified in the schedule to this certificate.

EC Type Examination Certificates without signature and seal are invalid.
This EC Type Examination Certificate may only be reproduced in its entirety and without any changes, schedule included.
Extracts or changes shall require the prior approval of the Physikalisch-Technische Bundesanstalt.

Physikalisch-Technische Bundesanstalt, Bundesallee 100, D-38116 Braunschweig
PtB18Ex n.doc

Test Report: **PTB Ex.03-22404**

(11) In compliance with the Directive 94/9/EC this Statement of Conformity relates only to the design and construction of the equipment specified. If applicable, further requirements of this Directive apply to the manufacture and marketing of the equipment.

(12) The marking of the equipment shall include the following:



Zertifizierungsstelle Explosionsschutz
By order

Braunschweig, 07 March 2003

(Signature) (Seal)

Dr. Ing. U. Johannsmeyer
Regierungsdirktor

EC Type Examination Certificates without signature and seal are invalid.
This EC Type Examination Certificate may only be reproduced in its entirety and without any changes, schedule included.
Extracts or changes shall require the prior approval of the Physikalisch-Technische Bundesanstalt.

Physikalisch-Technische Bundesanstalt, Bundesallee 100, D-38116 Braunschweig
PtB18Ex n.doc

PTB

Physikalisch-Technische Bundesanstalt
Braunschweig und Berlin

(13) **S c h e d u l e**

(14) **Statement of Conformity PTB 03 ATEX 2016 X**

(15) **Description of Equipment**

The Model 3730-28...e/p Positioner is a single- or double-acting positioner for attachment to linear or rotary actuators... It serves for adjusting valve stem positions to the control signal.

For supply air non-combustible media are used.

The device is intended for use inside and outside of hazardous locations.

The correlation between temperature classification and permissible ambient temperature ranges is shown in the table below:

Temperature class	Permissible ambient temperature range
T6	-40 °C ... 60 °C
T5	-40 °C ... 70 °C
T4	-40 °C ... 80 °C

The same data apply to the version with metallic cable entry.

Electrical data

Signal circuit (terminals 11/12)	Type of protection EEx nA II
Position indicator (terminals 31/32)	Type of protection EEx nA II
Inductive limit switch (terminals 41/42)	Type of protection EEx nA II
Software limit switch (terminals 41/42, 51/52)	Type of protection EEx nA II
Forced ventilation function (terminals 81/82)	Type of protection EEx nA II
Fault alarm output (terminals 83/84)	Type of protection EEx nA II
Programme Interface Adapter	Type of protection EEx nA II

EC Type Examination Certificates without signature and seal are invalid. This EC Type Examination Certificate may only be reproduced in its entirety and without any changes, schedule included. Extracts or changes shall require the prior approval of the Physikalisch-Technische Bundesanstalt.

Physikalisch-Technische Bundesanstalt, Bundesallee 100, D-38116 Braunschweig PhtBEEx n.doc

PTB

Physikalisch-Technische Bundesanstalt
Braunschweig und Berlin

(16) **Test Report: PTB Ex 03-22404**

(17) **Special conditions for safe use**

The Model 3730-28...e/p Positioner shall be installed in an enclosure providing at least Degree of Protection IP 54 in compliance with the IEC Publication 60529:1989. This requirement applies also to cable entries and/or plug connectors.

The wiring shall be connected in a manner that the connection facilities are not subjected to pull and/or twisting.

The signal circuit (terminals 11/12) shall be provided with a series connected fuse outside of the hazardous locations. This fuse shall comply with IEC 1217-2/II, 250 V F, or with IEC 1217-2/VI, 250 T, with a fuse nominal current of IN ≤ 63 mA.

The position indicator circuit shall be provided with a series connected fuse outside of the hazardous locations. This fuse shall comply with IEC 1217-2/II, 250 V F, or with IEC 1217-2/VI, 250 T, with fuse nominal current of IN ≤ 40 mA.

(18) **Special Health and Safety Requirements**

Are satisfied by compliance with the standards specified above.

Zertifizierungsstelle Explosionsschutz
By order

(Signature) (seal)
Dr. Ing. U. Johannsmeyer
Regierungsdirektor

Braunschweig, 7 March 2003

EC Type Examination Certificates without signature and seal are invalid. This EC Type Examination Certificate may only be reproduced in its entirety and without any changes, schedule included. Extracts or changes shall require the prior approval of the Physikalisch-Technische Bundesanstalt.

Physikalisch-Technische Bundesanstalt, Bundesallee 100, D-38116 Braunschweig PhtBEEx n.doc

Installation Manual for apparatus certified by CSA for use in hazardous locations.

Electrical rating of intrinsically safe apparatus and apparatus for installation in hazardous locations.

Table 1: Maximum values

Circuit No.	Control signal	Position indicator	Forced venting function Solenoid valve	Limit switches		Fault signal
				inductive	software	
	1	2	5	3 and 4	3 and 4	6
Terminal No.	11 / 12	31 / 32	81 / 82	41 / 42 and 51 / 52	41 / 42 and 51 / 52	83 / 84
U₀ or V_{max}	28V	28V	28V	16V	20V	20V
I₀ or I_{max}	115mA	115mA	115mA	2552 mA	60mA	60mA
P₀ or P_{max}	1W	500mW	500mW	64/165 mW	250mW	250mW
C₀	5.3nF	5.3nF	5.3nF	80nF	13.3nF	13.3nF
L₀	0μH	0μH	0μH	200μH	0μH	0μH

Circuit	Programming jack BU		External position sensor	
	Terminal	Connector	Analog pcb pin p9, p10, p11	
U₀ or V_{max}	20V	U ₀ or V _{cc}	U ₀ or V _{cc}	6.51V
I₀ or I_{max}	60mA	I ₀ or I _{sc}	I ₀ or I _{sc}	56mA
P₀ or P_{max}	250mW	P ₀	P ₀	91mW
C₀	0nF	C ₀	C ₀	11.2μF C=730nF
L₀	0μH	L ₀	L ₀	11.6mH L=370μH

Notes: Entity parameters must meet the following requirements:

$$U_0 \text{ or } V_{cc} \text{ or } V_i \leq U_0 \text{ or } V_{max} / I_0 \text{ or } I_{sc} \text{ or } I_i \leq I_0 \text{ or } I_{max} / P_0 \text{ or } P_{max} \leq P_0 \text{ or } P_{max}$$

$$C_0 \geq C_0 + C_{cable} \text{ and } L_0 \geq L_0 + L_{cable}$$

Table 2: CSA/FM – certified barrier parameters of circuit 2 and 5

Barrier	Supply barrier			Evaluation barrier			
	V _{cc}	R _{min}	I _{sc}	P _{max}	V _{cc}	R _{min}	I _{sc}
circuit 2	≤28V	≥300Ω	≤115mA	≤1W	≤28V	#	0mA
circuit 5	≤28V	≥392Ω	≤115mA	≤500mW	≤28V	#	0mA

Table 3: The correlation between temperature classification and permissible ambient temperature ranges is shown in the table below:

Temperature class	Permissible ambient temperature range
T6	-40°C ... 60°C
T5	-40°C ... 70°C
T4	-40°C ... 80°C

Table 4: For the Model 3730 – 231 ... Positioner the correlation between temperature classification, permissible ambient temperature ranges and maximum short-circuit current is shown in the table below:

Temperature class	Permissible ambient temperature range	Maximum short-circuit current
T6	-40°C ... 45°C	52mA
T5	-40°C ... 60°C	
T4	-40°C ... 75°C	
T6	-40°C ... 60°C	25mA
T5	-40°C ... 80°C	
T4	-40°C ... 80°C	

Addendum Page 3
 Intrinsically safe if installed as specified in manufacturer's installation manual.
CSA- certified for hazardous locations

Ex in IIC TEs; Class I, Zone 0
 Class I Div. 1, Groups A, B, C, D,
 Class II Div. 1, Groups E, F + G,
 Type 4 Enclosure

Notes:

- 1.) The apparatus may be installed in intrinsically safe circuits only when used in conjunction with CSA certified apparatus. For maximum values of $U_{or} V_{max}$; $I_{or} I_{max}$; P_{or} or P_{max} ; see CL of the various apparatus see Table 1 on page 1.
- 2.) For barrier selection see Table 2 on page 2.
- 3.) The installation must be in accordance with the C. E. C. Part 1.
- 4.) Use only supply wires suitable for 5°C above surrounding temperature.
- 5.) For CSA Certification, Safety Barrier must be CSA Certified and installed in accordance with C.E.C. Part 1. Each pair of I.S. wires must be protected by a shield that is grounded at the I.S. Ground. The shield must extend as close to the terminals as possible.

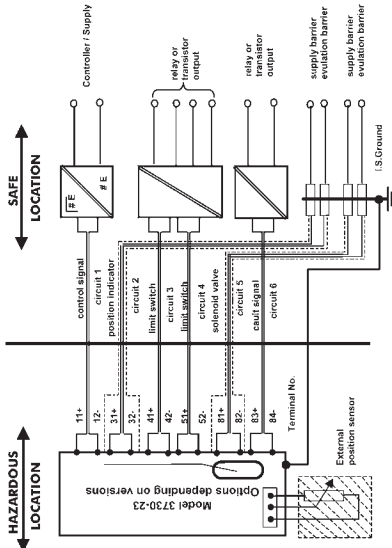

Controller, CSA/FM - certified.
Relay or transistor output 1 or 2 channel(s) resp. CSA/FM - certified
Supply and evaluation barrier CSA/FM - certified

For the permissible maximum values for the intrinsically safe circuits 1, 3, 4 and 6 see Table 1
 For the permissible barrier parameters for the circuits 2 and 5 see Table 2
 Cable entry M 20 x 1.5 or metal conduit according to drawing No. 1050 - 0539 T
 or 1050 - 0540 T

Revision Control Number: 2 March 03

Addendum to EB 8384-2EN

Addendum Page 4

On interconnection to form ground-free signal circuits, only evaluation barriers must be installed in the return line. Correct polarity must be ensured.

Circuit diagram of a ground-free signal circuit:
 (position indicator and forced venting function)

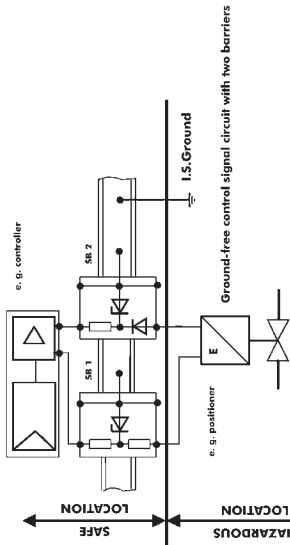

In grounded signal circuits with only one barrier, the return line must be grounded or included in the potential equalization network of the system.

Circuit diagram of a grounded signal circuit:
 (position indicator and forced venting function)

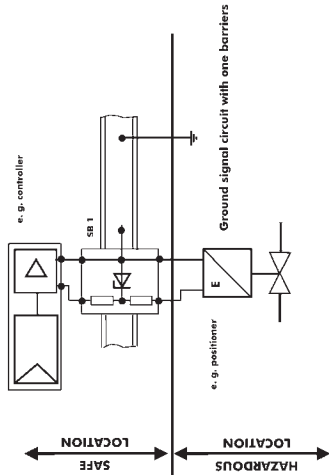

Revision Control Number: 2 March 03

Addendum to EB 8384-2EN

CSA - certified for hazardous locations
 Class I, Zone 2
 Class I, Division 2, Groups A, B, C, D,
 Class II, Groups E, F + G.

Type 4 Enclosure

e/p - positioner with position indicator, forced venting function (solenoid valve), fault signal and limit switches.

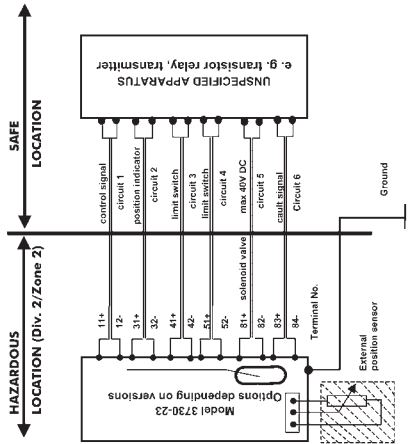

Notes:

- 1.) The installation must be in accordance with the Canadian Electrical Code, Part 1
- 2.) For the maximum values for the individual circuits see Table 1 and 2.
- 3.) The cables shall be protected by conduits.
- 4.) Cable entry only rigid metal conduit according to drawing No. 1050-0539 I and 1050-0540 I

Installation drawing Control Relay KHA5-OTI/Ex2, KHA6-OTI/Ex1 or
 KHA6-OTI/Ex2 with Model SJ-b-N Proximity Sensors

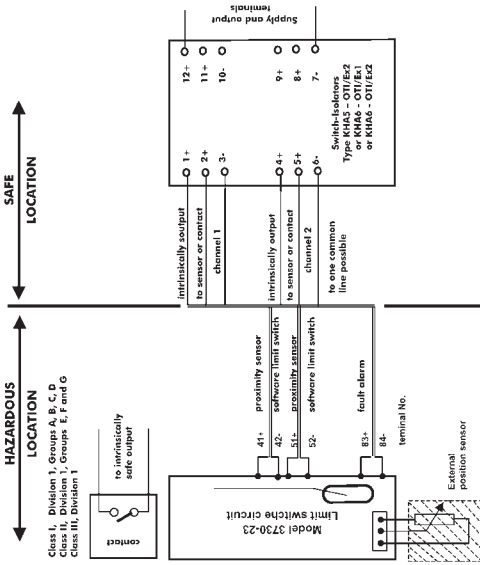

maximum capacitance of each inductive sensor 40nF
 maximum inductance of each inductive sensor 200µH

The total series inductance and shunt capacitance of shield wiring shall be restricted to the following maximum values

Control Relay Terminal No.	Groups	L [mH]	C [µF]	V _{OC} [V]	I _{SC} [mA]
1-3, 2-3 4-6, 5-6	A + B	84,8	1,27	↔	↔
	C	299	3,82	12,0	19,8
	D	744	10,2	↔	↔

Each pair of U.S. wires must be protected by a shield that is grounded at the U.S. end of the shield. The shield wires must be to the terminals as possible install per C.E.C. Part 1.

Installation Manual for apparatus approved by FM for use in hazardous locations.
Electrical rating of intrinsically safe apparatus and apparatus for installation in hazardous locations.

Table 1: Maximum values

Circuit No.	Control signal	Position indicator	Forced venting function Solenoid valve	Limit switches		Fault signal
				Inductive	software	
	1	2	5	3 and 4	3 and 4	6
Terminal No.	11 / 12	31 / 32	81 / 82	41 / 42 and 51 / 52	41 / 42 and 51 / 52	83 / 84
U _i or V _{max}	28V	28V	28V	16V	20V	20V
I _i or I _{max}	115mA	115mA	115mA	25/52 mA	60mA	60mA
P _i or P _{max}	1W	500mW	500mW	64/163 mW	250mW	250mW
C _i	5.3nF	5.3nF	5.3nF	60nF	13.4nF	13.4nF
L _i	0μH	0μH	0μH	100μH	0μH	0μH

Circuit	Terminal	Programming jack BU		External position sensor	
		Connector	Analog pcb pin p9, p10, p11	U _o or V _{oc}	I _o or I _{sc}
U _i or V _{max}	20V	U _o or V _{oc}	6.51V	U _o or V _{oc}	6.51V
I _i or I _{max}	60mA	I _o or I _{sc}	57.5mA	I _o or I _{sc}	56mA
P _i or P _{max}	250mW	P _o	94mW	P _o	91mW
C _i	0nF	C _o	22μF	C _o	11.2μF C _i =730nF
L _i	0μH	L _o	10mH	L _o	11.6mH L _i =370μH

Notes: Entity parameters shall meet the following requirements:

U_o or V_{oc} or V_i ≤ U_i or V_{max} / I_o or I_{sc} or I_i ≤ I_i or I_{max} / P_o or P_{max} ≤ P_i or P_{max}
C_o ≥ C_i + C_{cable} and L_o ≥ L_i + L_{cable}

Table 2: FM/ CSA – approved barrier parameters of circuit 2 and 5

Barrier	Supply barrier				Evaluation barrier			
	V _{oc}	R _{min}	I _{sc}	P _{max}	V _{oc}	R _{min}	I _{sc}	#
circuit 2	528V	≥196Ω	≤115mA	≤1W	528V	≥28V	0mA	0mA
circuit 5	528V	≥392Ω	≤115mA	≤500mW	528V	≥28V	0mA	0mA

Table 3: The correlation between temperature classification and permissible ambient temperature ranges is shown in the table below:

Temperature class	Permissible ambient temperature range
T6	-40°C ... 60°C
T5	-40°C ... 70°C
T4	-40°C ... 80°C

Table 4: For the Model 3730 – Z31 ... Positioner the correlation between temperature classification, permissible ambient temperature ranges and maximum short-circuit current is shown in the table below:

Temperature class	Permissible ambient temperature range	Maximum short-circuit current
T6	-40°C ... 45°C	52mA
T5	-40°C ... 60°C	
T4	-40°C ... 75°C	
T6	-40°C ... 60°C	25mA
T5	-40°C ... 80°C	
T4	-40 C ... 80 C	

FM- approved for hazardous locations

Class I, Division 2, Groups A, B, C, D,
Class II, Division 2 Groups F + G.

NEMA 4X

e/p - positioner with position indicator, forced venting function (solenoid valve), fault signal and limit switches.

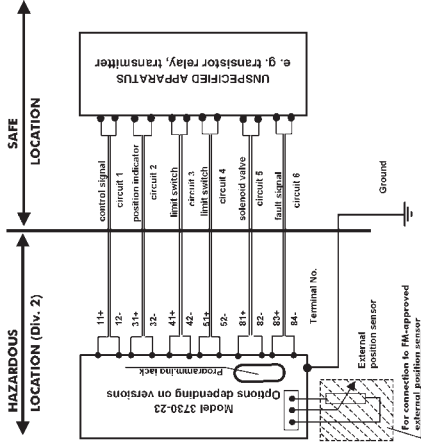

Notes:

1.) The installation shall be in accordance with the National Electrical Code ANS/NFPA 70

For the maximum values for the individual circuits see Table 1
Cable entry only rigid metal conduit

Intrinsically safe if installed as specified in manufacturer's installation manual.
FM- approved for hazardous locations

Class I, Zone 0 A Ex ia IIC T6;

Class I, II, III, Div. 1, Groups A, B, C, D, E, F + G;

NEMA 4X

Notes:

- 1.) The apparatus may be installed in intrinsically safe circuits only when used in conjunction with FM/CSA approved apparatus. For maximum values of U_{or} , V_{max} , I_t or I_{max} , For P_{max} , C and L of the various apparatus see Table 1 on page 7.
- 2.) For barrier selection see Table 2 on page 8.
- 3.) The installation shall be in accordance with the National Electrical Code ANS/NFPA 70 and ANS/ISA RP 12.06.01.
- 4.) Use only supply wires suitable for 5°C above surrounding temperature.

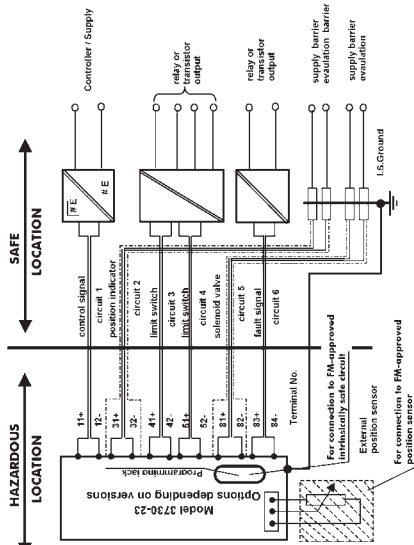

- For the permissible maximum values for the intrinsically safe circuits 1, 3, 4, and 6 see Table 1
For the permissible barrier parameters for the circuits 2, and 5 see Table 2
Cable entry M 20 x 1.5 or metal conduit according to drawing No. 1050 - 0539 T
or 1050 - 0540 T

Addendum Page 11
Installation drawing Control Relay KHab-cEx de Model SJ-b-N Proximity Sensors

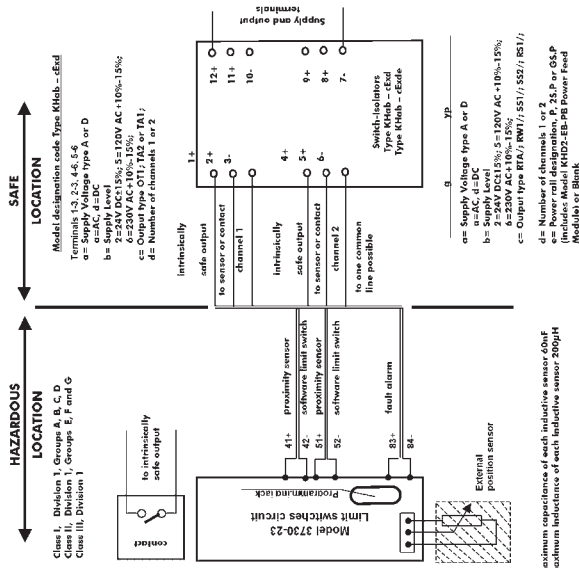

The total series inductance and shunt capacitance at shield wiring shall be restricted to the following maximum values:

Control Relay Terminal No.	Groups	L [mH]	C [µF]	V _{OC} [V]	I _{SC} [mA]
1-2; 7-3 4-6; 5-6	A + B	84,8	1,27	↑	↑
	C	299	3,82	12,9	19,8
	D	744	10,2	↓	↓



SAMSON AG · MESS- UND REGELTECHNIK
Weismüllerstraße 3 · 60314 Frankfurt am Main · Germany
Phone: + 49 69 4009-0 · Fax: +49 69 4009-1507
Internet: <http://www.samson.de>

EB 8384-2 EN

S/Z 2005-04